



Darshan Extrusions Pvt. Ltd.

Die No.19056

0.352KG/M

Die No.19169

0.429KG/M

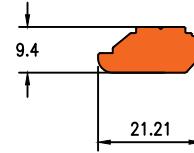
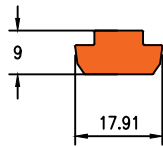

Die No.19057

0.392KG/M

Die No.19181

0.661KG/M

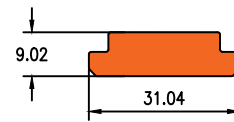
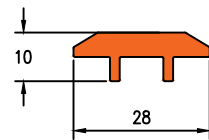

Die No.19131

0.389KG/M

Die No.19006

0.389KG/M

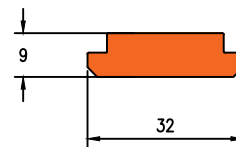
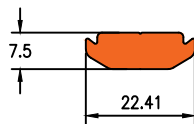

Die No.19159

0.203KG/M

Die No.19163

0.205KG/M

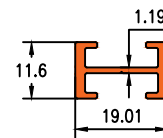
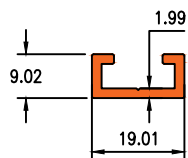

SOLAR



Darshan Extrusions Pvt. Ltd.

Die No.19069

0.809KG/M

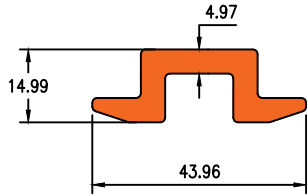

Die No.19432

0.750KG/M

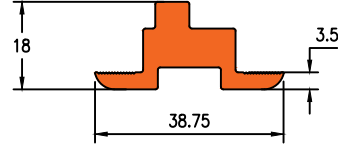

Die No.19811

0.277KG/M

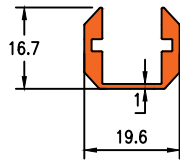

Die No.19831

0.247KG/M

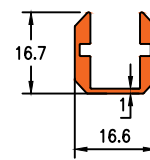

Die No. 19130

0.260KG/M

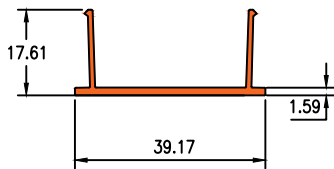

Die No.10203

0.358KG/M

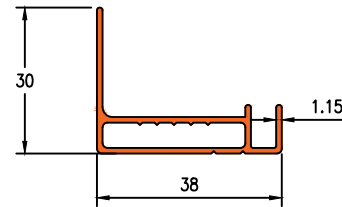

Die No.7001

0.786KG/M

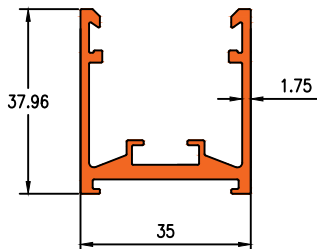

Die No.19051

0.695KG/M

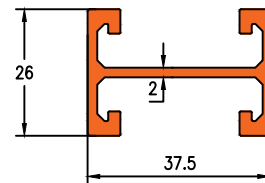

SOLAR



Darshan Extrusions Pvt. Ltd.

Die No. 7002

0.647KG/M

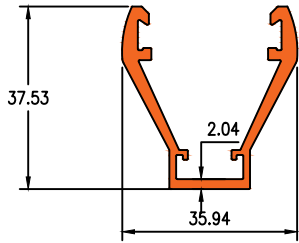

Die No. 7003

0.590KG/M

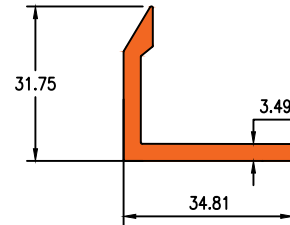

Die No. 19135

0.551KG/M

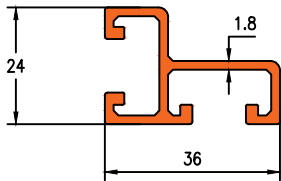

Die No. 19162

0.909KG/M

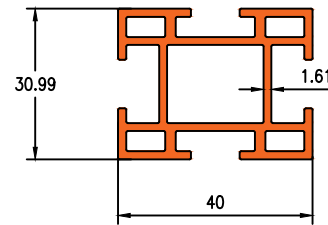

Die No. 7006

0.495KG/M

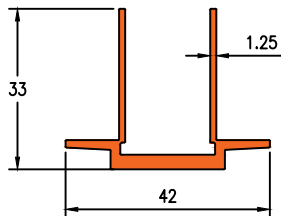

Die No. 7037

0.822KG/M

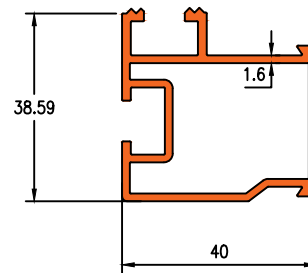

Die No. 7047

0.189KG/M

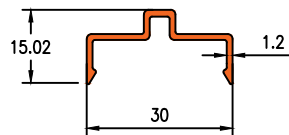

Die No. 7048

0.632KG/M

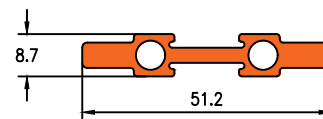

SOLAR



Darshan Extrusions Pvt. Ltd.

Die No. 7049

0.222KG/M

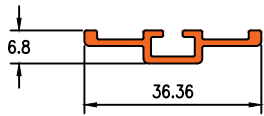

Die No. 19054

0.921KG/M

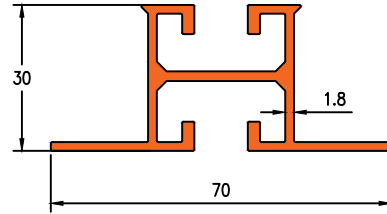

Die No. 7004

0.757KG/M

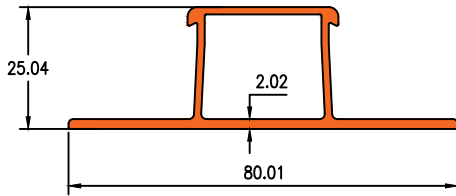

Die No. 19196

0.972KG/M

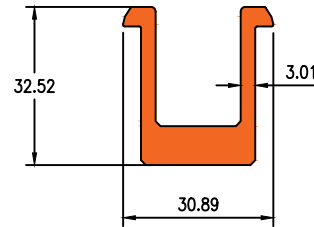

Die No. 19039

0.617KG/M

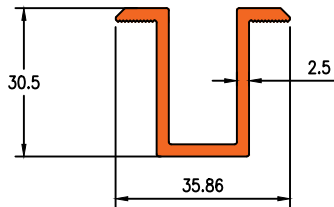

Die No. 19005

0.681KG/M

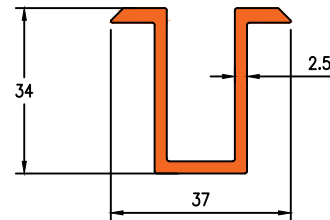

Die No. 19374

2.876KG/M

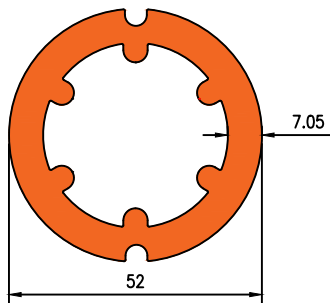

Die No. 19133

0.749KG/M

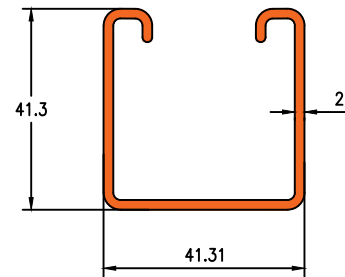

SOLAR



Darshan Extrusions Pvt. Ltd.

Die No.19040

0.534KG/M

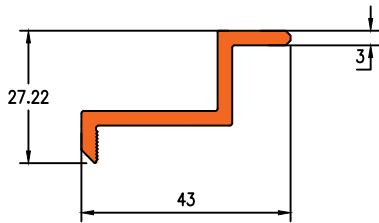

Die No.19043

0.565KG/M

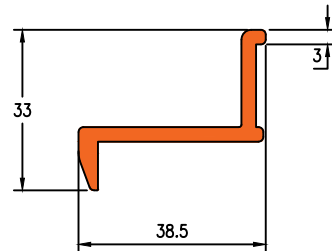

Die No.19044

0.606KG/M

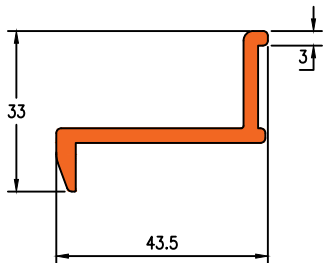

Die No.19055

0.529KG/M

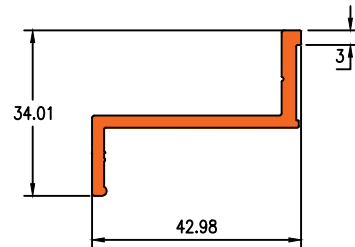

Die No.20055

0.656KG/M

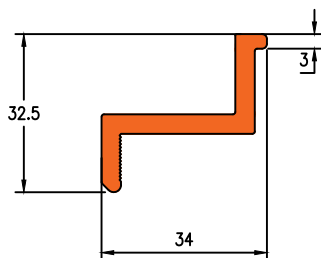

Die No.19070

0.403KG/M

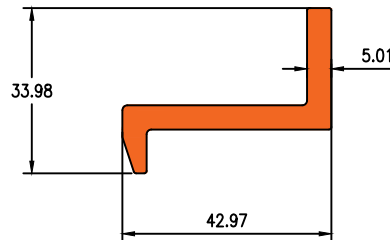

Die No.19004

0.576KG/M

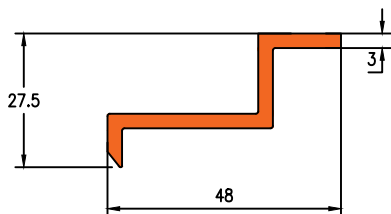

Die No.20055

0.656KG/M

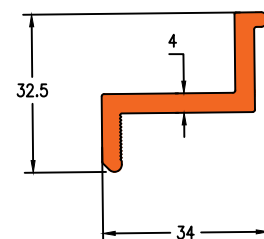

SOLAR



Darshan Extrusions Pvt. Ltd.

Die No.7028

1.176KG/M

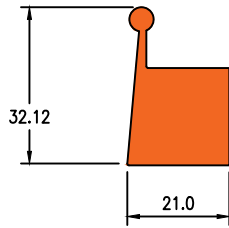

Die No.7026

0.269KG/M

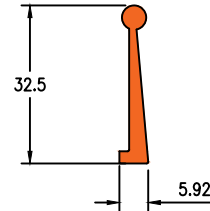

Die No.7027

2.489KG/M

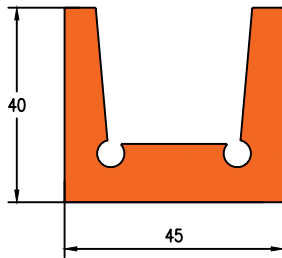

Die No.19042

3.465KG/M

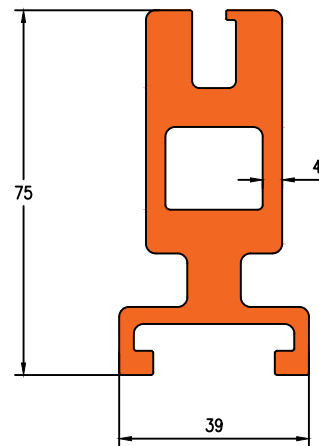

SOLAR



Darshan Extrusions Pvt. Ltd.

Die No.19041

4.561KG/M

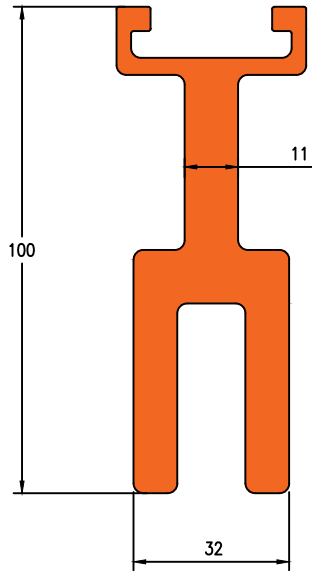

Die No.19488

3.022KG/M

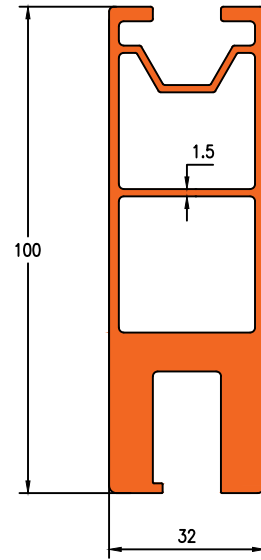

Die No.19097

1.458KG/M

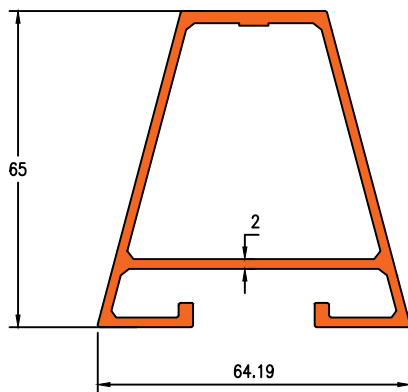

Die No.16104

1.593KG/M

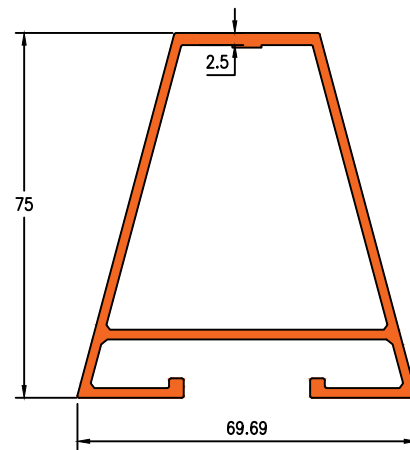

SOLAR



Darshan Extrusions Pvt. Ltd.

Die No.19007

1.218KG/M

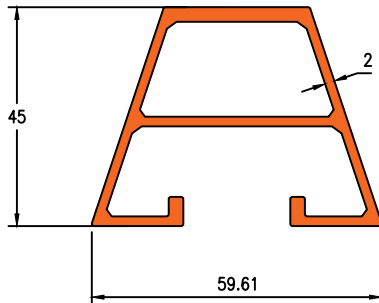

Die No.19087

1.030KG/M

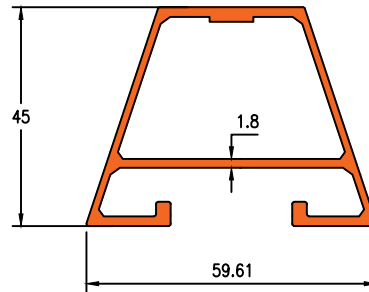

Die No.16217

1.298KG/M

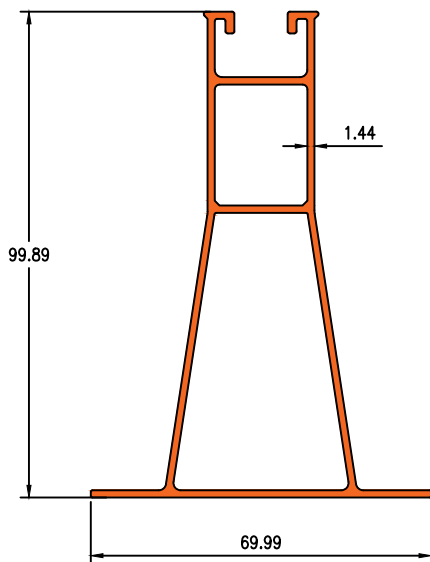

Die No.19433

1.669KG/M

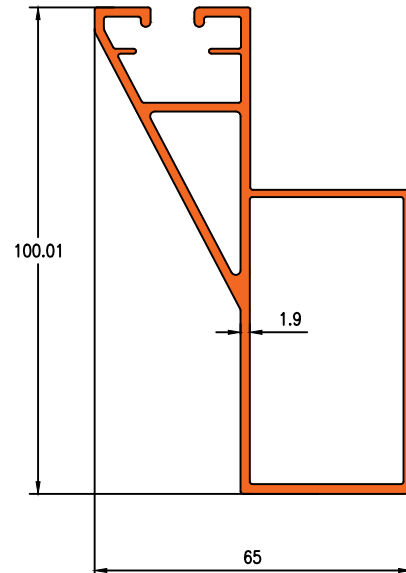

Die No.19999

1.254KG/M

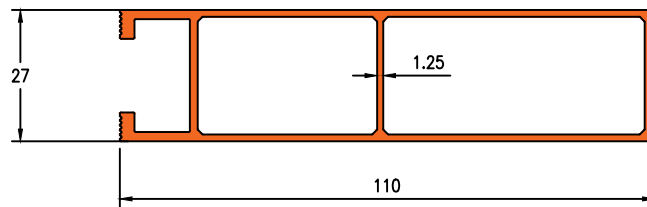

SOLAR



Darshan Extrusions Pvt. Ltd.

Die No.19165

1.217KG/M

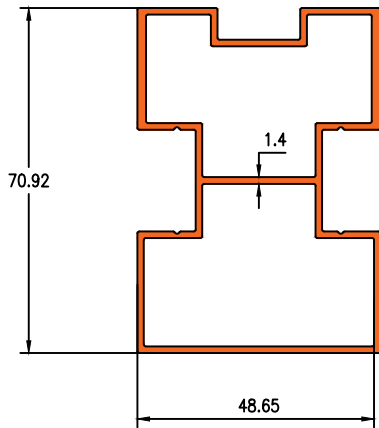

Die No.19160

1.286KG/M

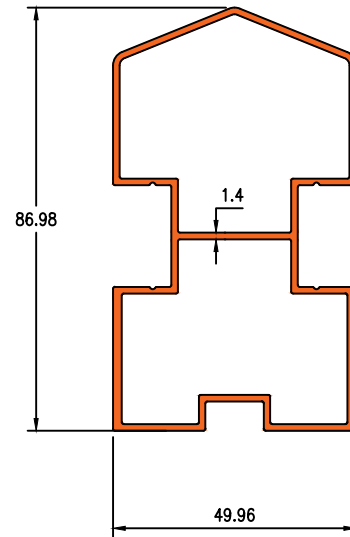

Die No.19079

1.056KG/M

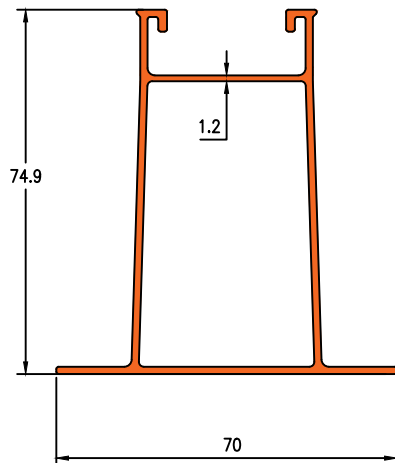

Die No.21020

1.309KG/M

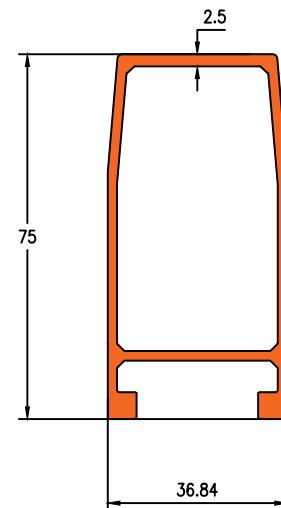

SOLAR



Die No.19999

1.254KG/M

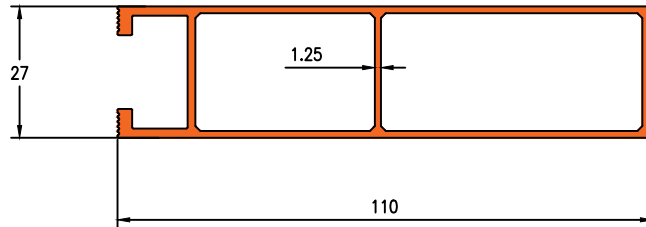

Die No.21020

1.309KG/M

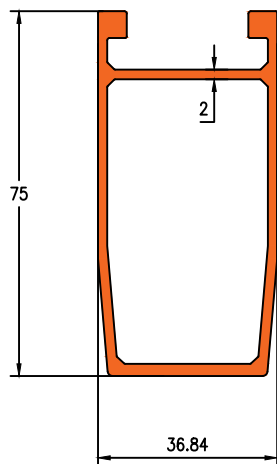

Die No.22101

2.302KG/M

