

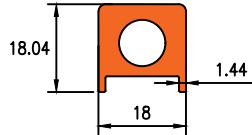

Darshan Extrusions Pvt. Ltd.

Die No.16228

0.549KG/M



Die No. 19466

0.329KG/M

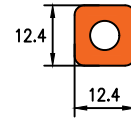

Die No.1255

4.112KG/M

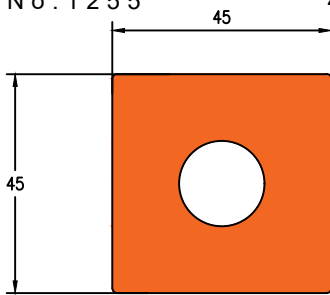

Die No.19115

2.273KG/M

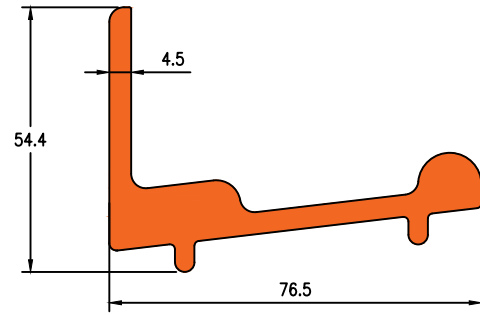

Die No.19108

7.133KG/M

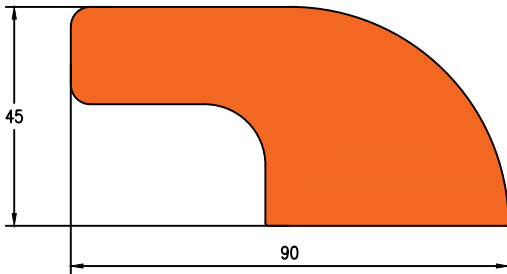

Die No.19114

2.663KG/M

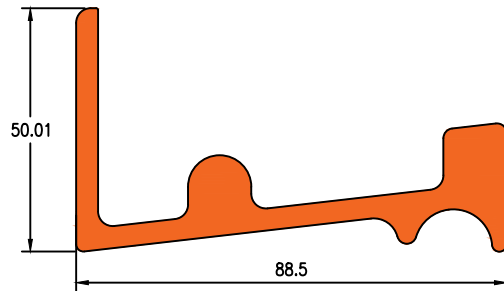

Die No.19017

7.255KG/M

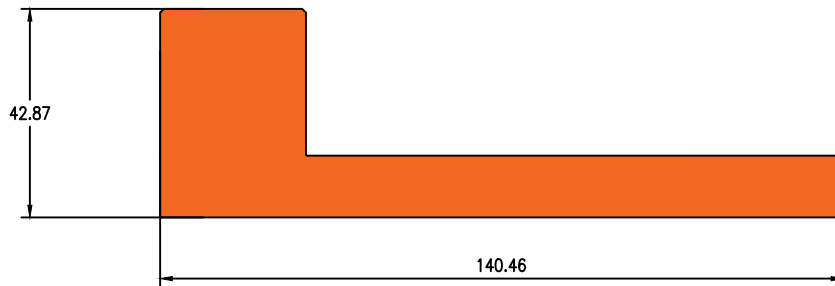

INDUSTRIAL



Darshan Extrusions Pvt. Ltd.

Die No. 19342

4.863KG/M

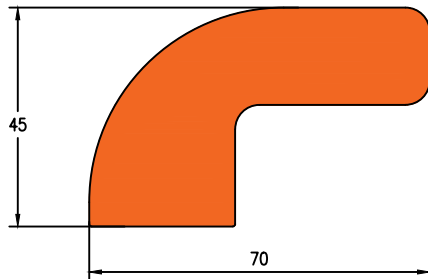

Die No.19095

2.283KG/M

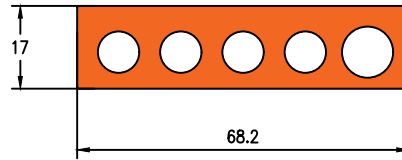

Die No.19096

4.020KG/M

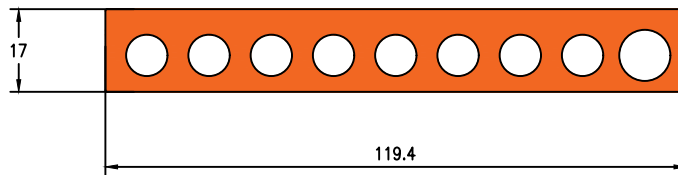

Die No. 19653

1.158KG/M

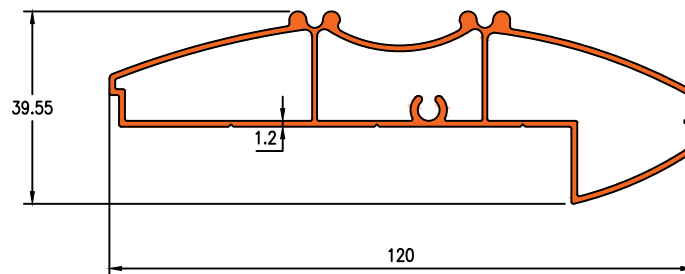

Die No.19035

3.003KG/M

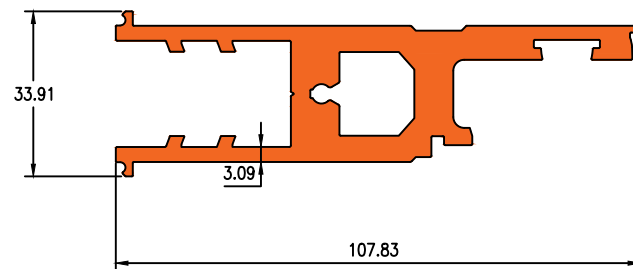

INDUSTRIAL



Darshan Extrusions Pvt. Ltd.

Die No.19090

3.175KG/M

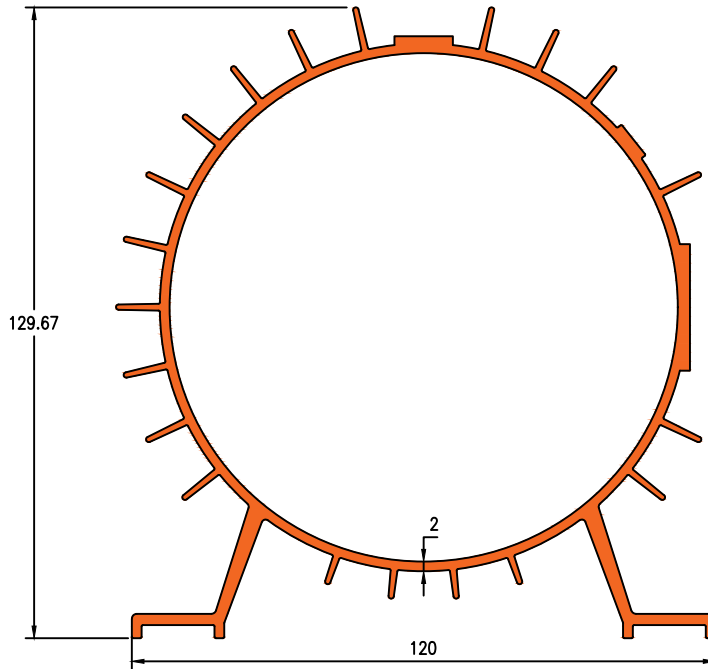

Die No. 16248

0.274KG/M

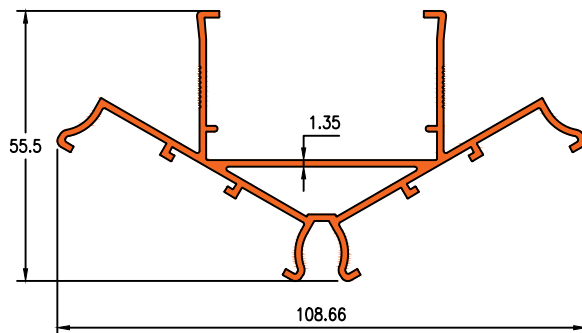

Die No. 19460

3.820KG/M

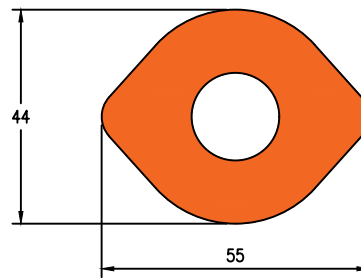

MOTOR BODY