

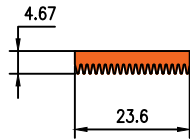

# Darshan Extrusions Pvt. Ltd.

Die No. 19036

0.237KG/M



Die No. 19037

2.133KG/M

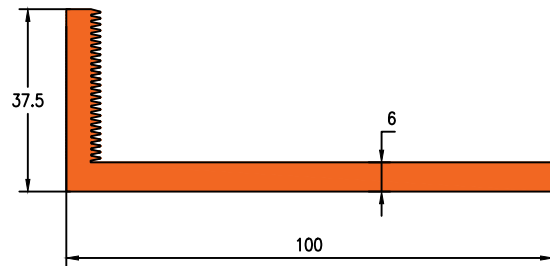

Die No. 11101

5.067KG/M

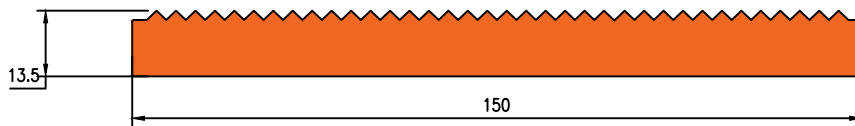

Die No. 19038

2.083KG/M

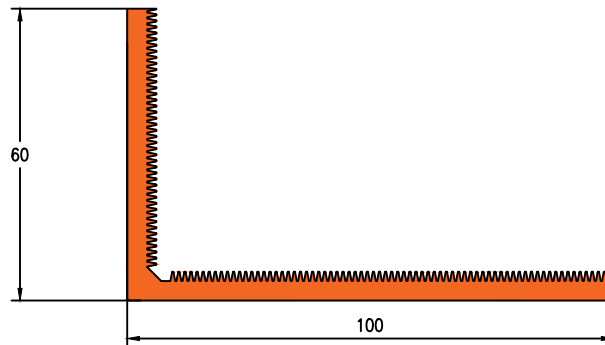

Die No. 19127

0.508KG/M

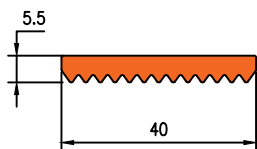

Die No. 1356

1.539KG/M

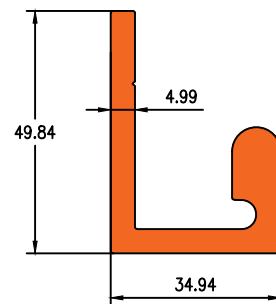

ARCHITECTURAL



# Darshan Extrusions Pvt. Ltd.

Die No. 19060

0.608KG/M

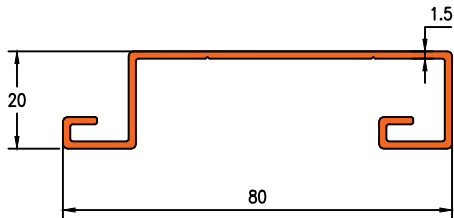

Die No. 1285

0.641KG/M

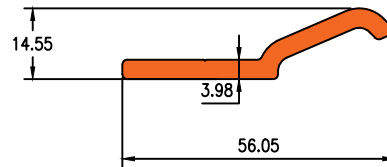

Die No. 1466

0.605KG/M

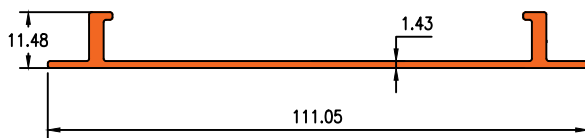

Die No. 401

0.120KG/M

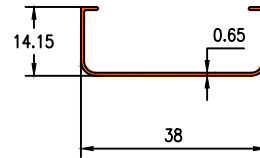

Die No. 19126

3.158KG/M

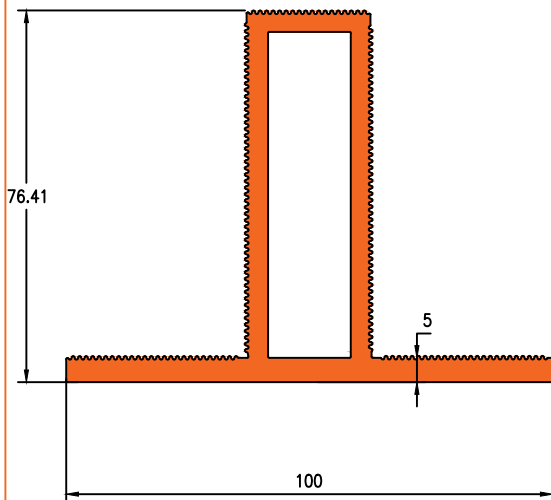

Die No. 1426

1.267KG/M

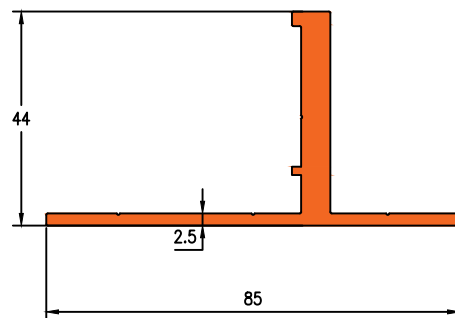

ARCHITECTURAL



# Darshan Extrusions Pvt. Ltd.

Die No. 19061

0.829KG/M

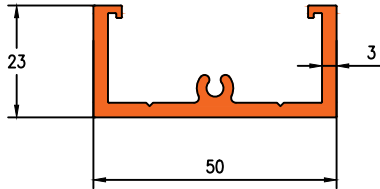

Die No. 19065

1.144KG/M

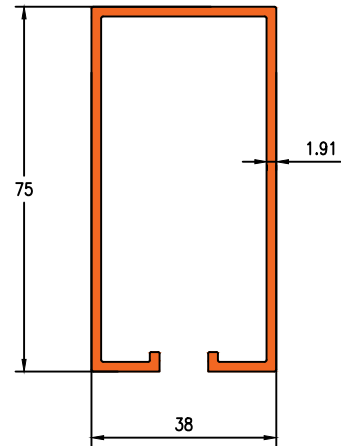

Die No. 7110

0.232KG/M

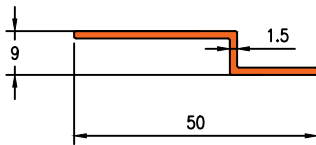

Die No. 19128

0.163KG/M

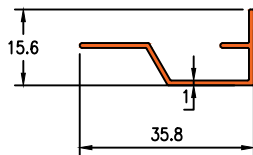

Die No. 27022

0.632KG/M

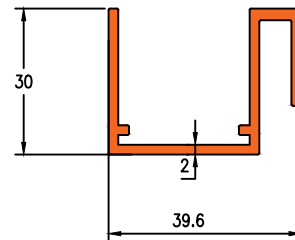

Die No. 19132

0.766KG/M

0.669KG/M

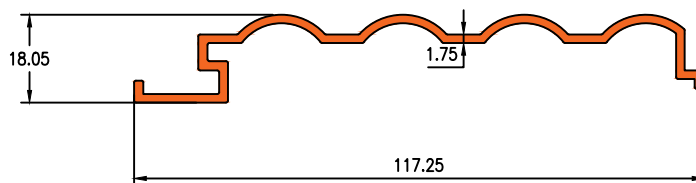

ARCHITECTURAL



# Darshan Extrusions Pvt. Ltd.

Die No. 27020

0.771KG/M

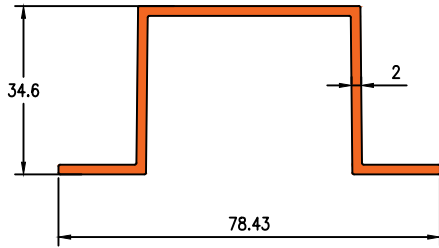

Die No. 27023

0.671KG/M

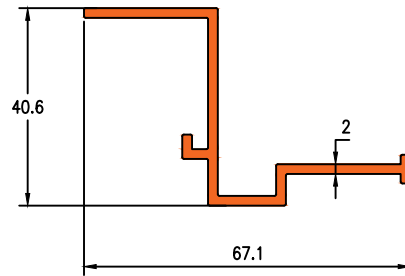

Die No. 27021

1.634KG/M

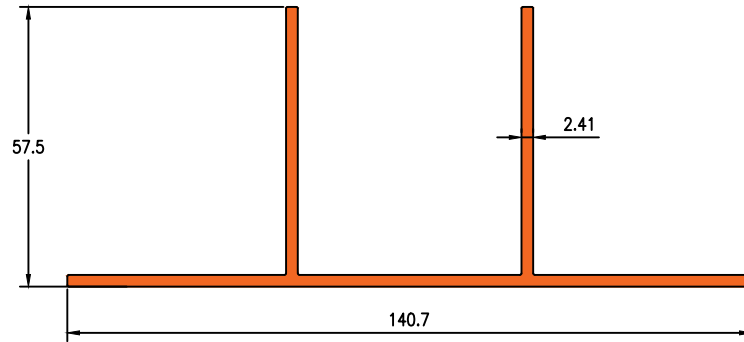

Die No. 7091

1.380KG/M

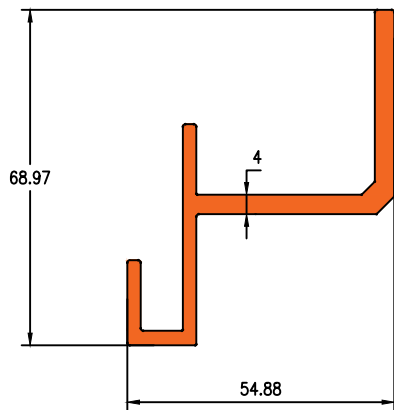

Die No. 27024

0.782KG/M

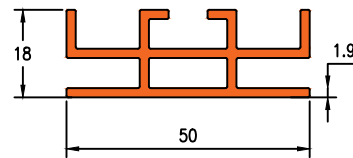

Die No. 7092

1.435KG/M

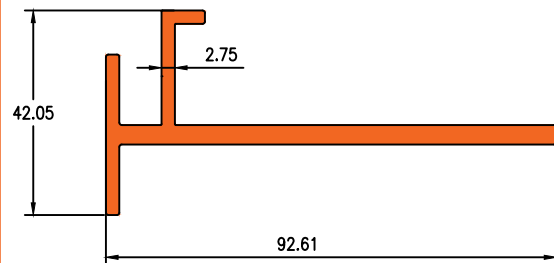



# Darshan Extrusions Pvt. Ltd.

Die No. 19164

1.060KG/M

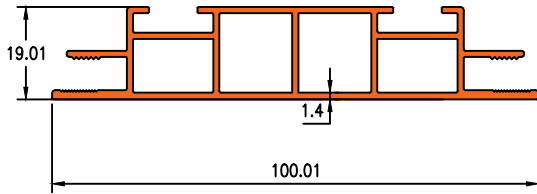

Die No. 19170

1.342KG/M

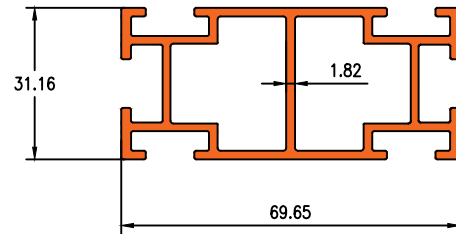

Die No. 19171

0.383KG/M

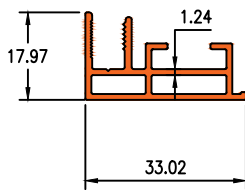

Die No. 19172

0.422KG/M

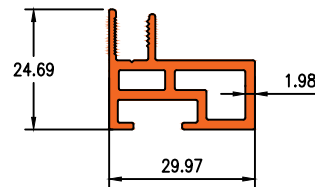

Die No. 19175

0.432KG/M

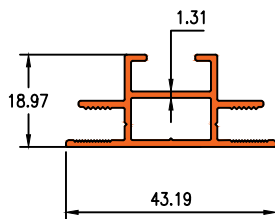

Die No. PD-101

0.779KG/M

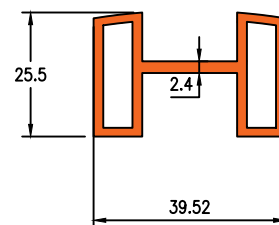

Die No. 19176

1.536KG/M

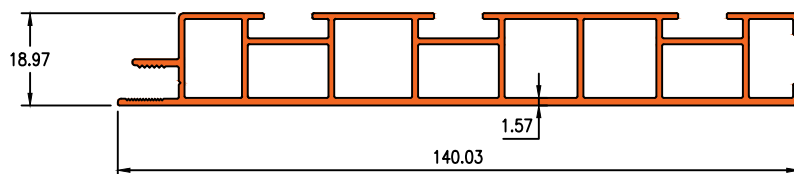



# Darshan Extrusions Pvt. Ltd.

Die No. 19610

3.554KG/M

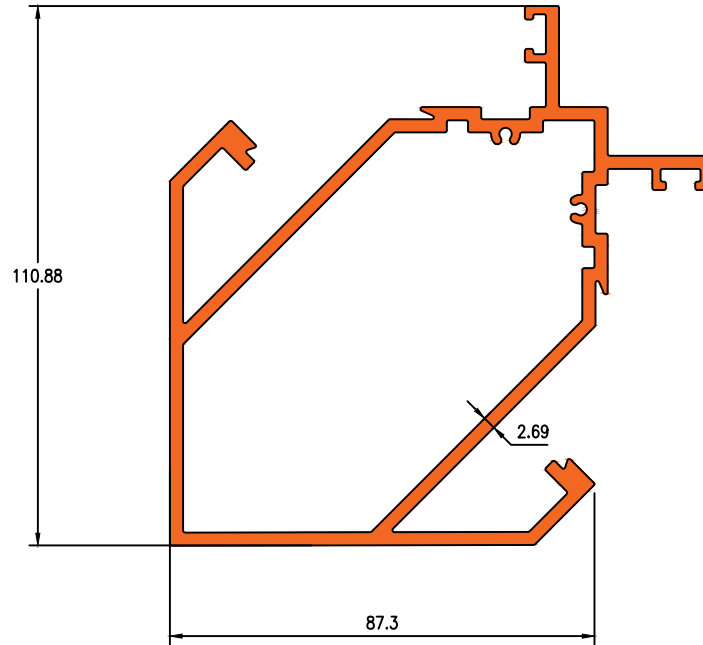

Die No. PD-102

0.917KG/M

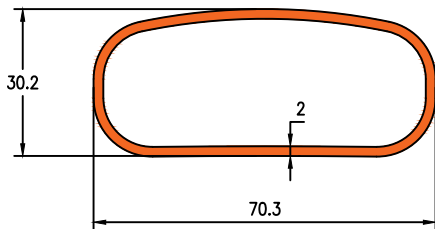

Die No. 19827

1.668KG/M

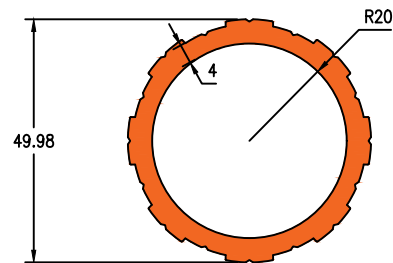

Die No. 11320

0.197KG/M

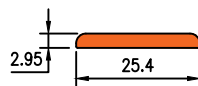

Die No. 21001

0.253 KG/M

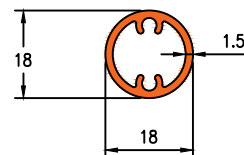

ARCHITECTURAL



# Darshan Extrusions Pvt. Ltd.

Die No. 16011

0.307KG/M

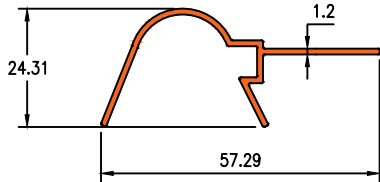

Die No. 16016

0.071KG/M

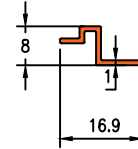

Die No. 19476

0.555 KG/M

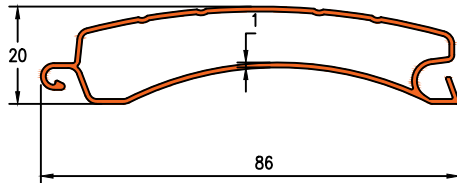

Die No. 7050

0.306KG/M

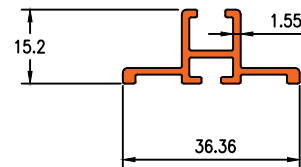

Die No. 1468

0.191KG/M

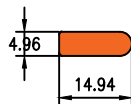

Die No. 1461

0.112KG/M

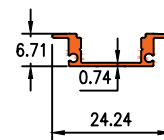

Die No. 1410

0.248KG/M

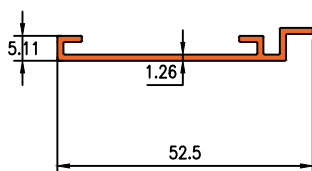

Die No. 1453

0.264KG/M

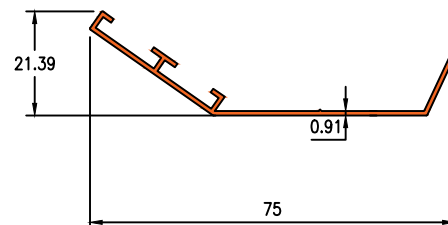

ARCHITECTURAL



# Darshan Extrusions Pvt. Ltd.

Die No. 1360

1.527KG/M

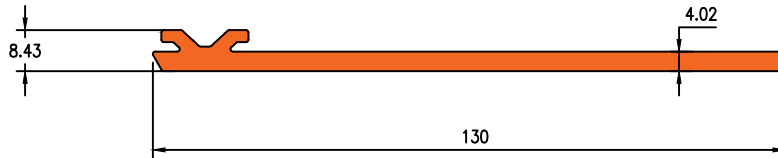

Die No. 1361

1.088KG/M

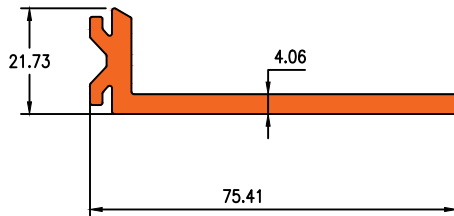

Die No. 1455

0.828KG/M

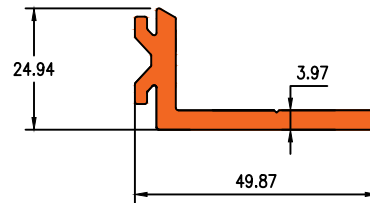

Die No. 1359

1.663KG/M

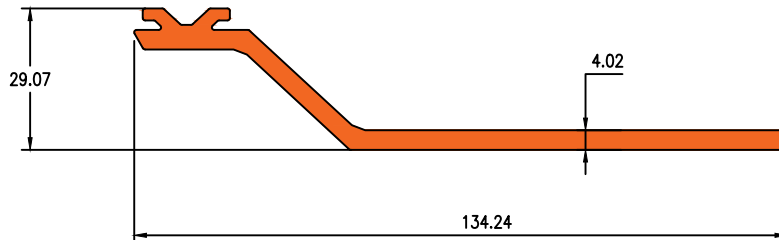

Die No. 1456

1.869KG/M

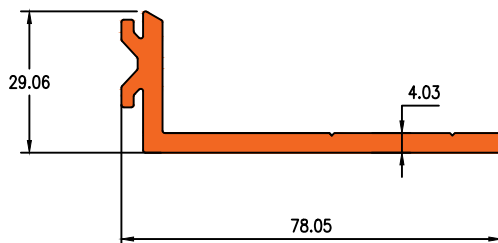

Die No. 1357

1.053KG/M

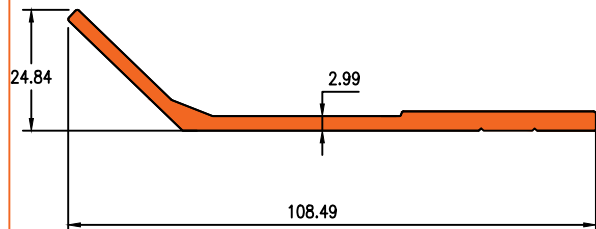

BRACKETS



# Darshan Extrusions Pvt. Ltd.

Die No. 1370

0.164KG/M

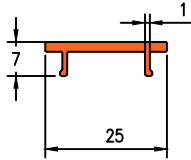

Die No. 1369

0.917KG/M

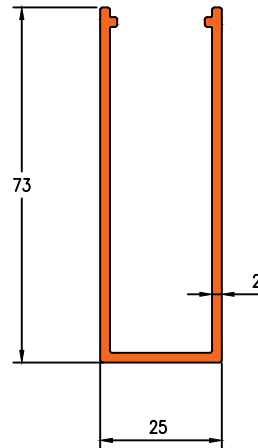

Die No. 1300

0.504KG/M

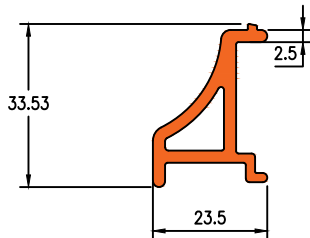

Die No. 1324

0.823KG/M

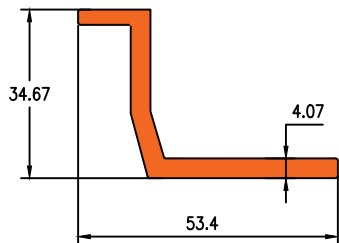

Die No. 1323

0.827KG/M

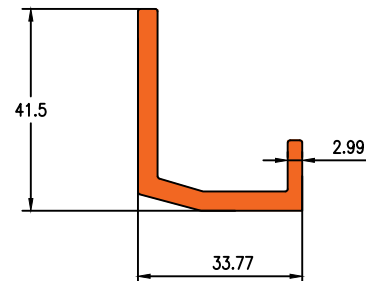

Die No. 1358

1.887KG/M

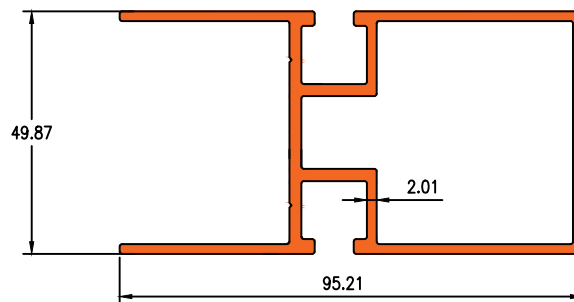



# Darshan Extrusions Pvt. Ltd.

Die No. 1424

1.577KG/M

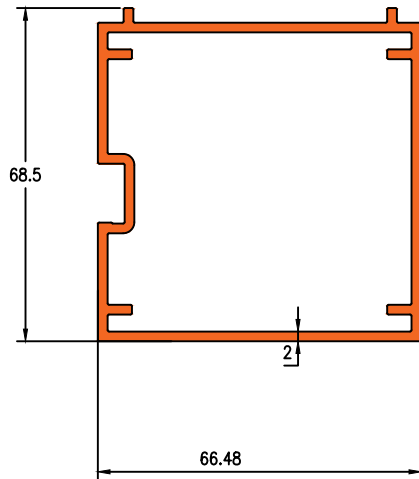

Die No. 1423

0.541KG/M

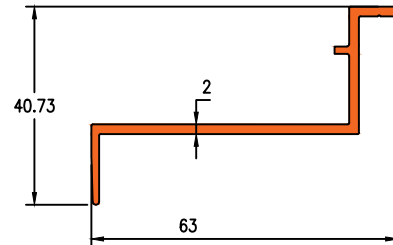

Die No. 1406

0.997 KG/M

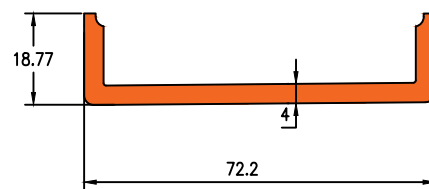

Die No. 1430

0.476KG/M

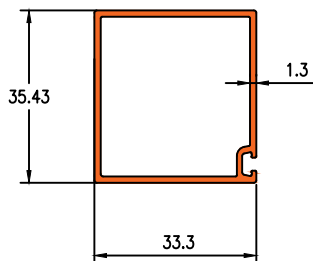

Die No. 1429

1.599 KG/M

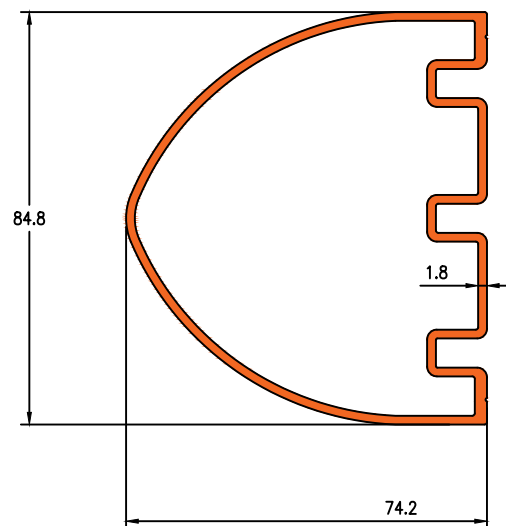

Die No. 1233

1.060KG/M

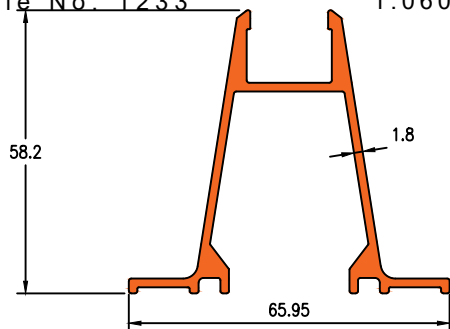

ARCHITECUTRAL



# Darshan Extrusions Pvt. Ltd.

Die No. 1234

0.623KG/M

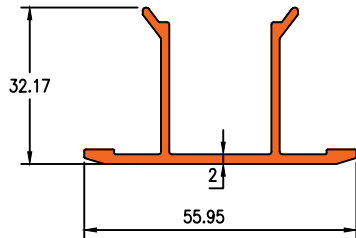

Die No. 1450

0.556KG/M

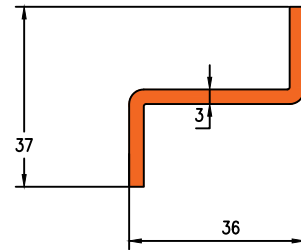

Die No. 1448

1.275KG/M

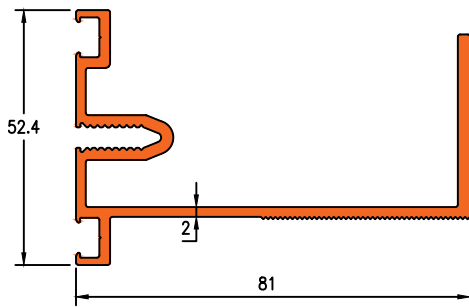

Die No. 1472

0.215KG/M

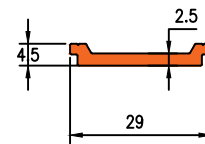

Die No. 1474

1.459KG/M

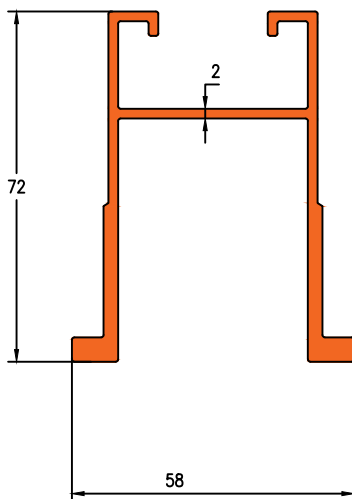

Die No. 1327

0.393KG/M

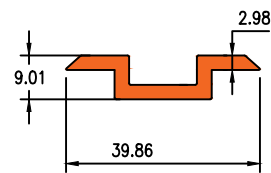

Die No. 1375

1.642KG/M

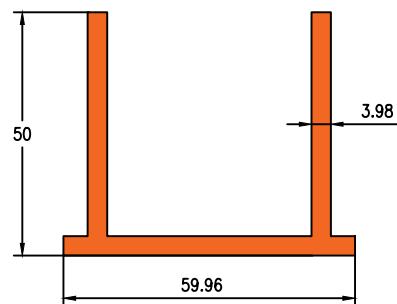

ARCHITECUTRAL



Die No. 19146

1.506 KG/M

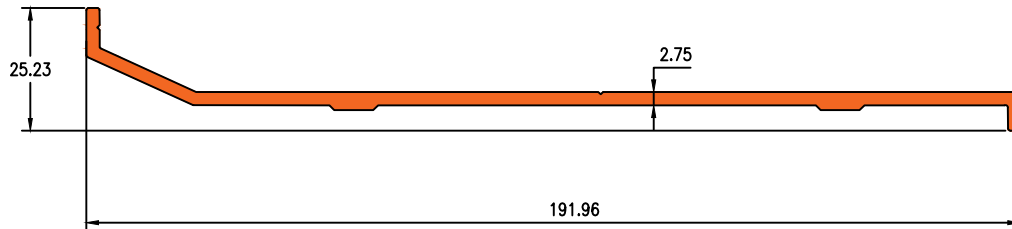

Die No. 19147

1.601 KG/M

