

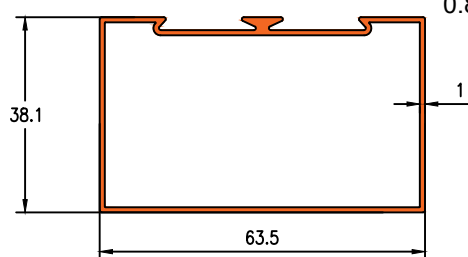

Darshan Extrusions Pvt. Ltd.

Die No. 1701

0.519 Kg/m
0.683 kg/m
0.846 kg/m



Die No. 1721

0.519 Kg/m
0.683 kg/m
0.846 kg/m

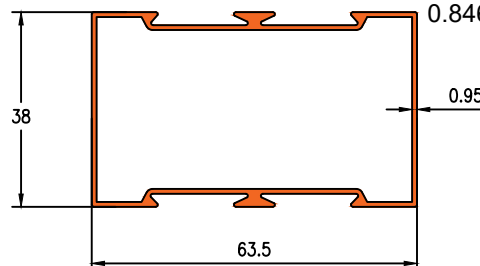

Die No. 1480

0.732 Kg/m

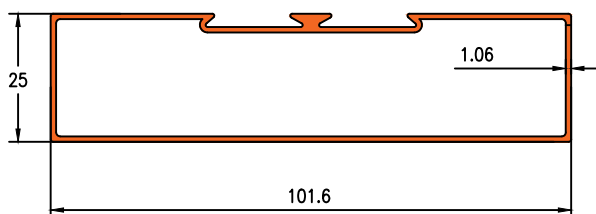

Die No. 1481

0.833 Kg/m

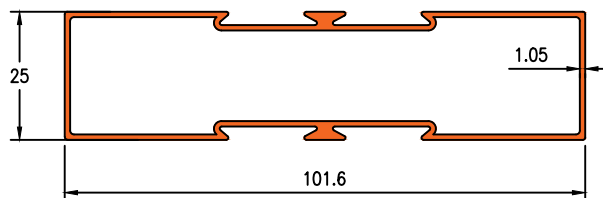

Die No. 21142

0.726 Kg/m

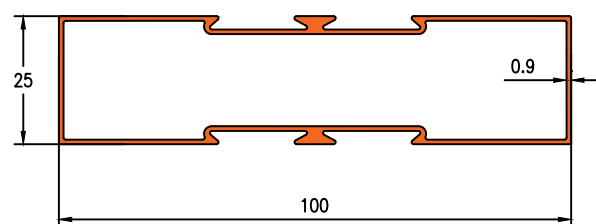

Die No. 1771

1.502 Kg/m
2.377 kg/m

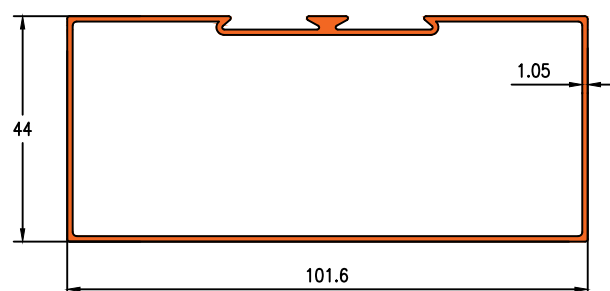

Die No. 1791

1.502 Kg/m
2.431 kg/m

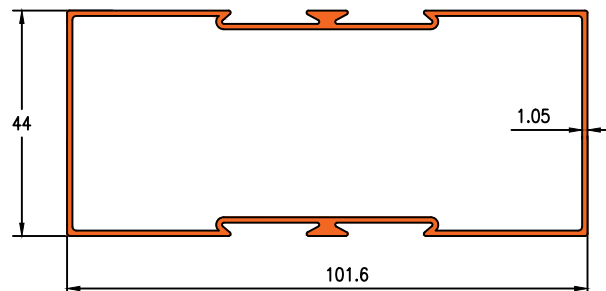



Darshan Extrusions Pvt. Ltd.

Die No. 3503

0.732 Kg/m

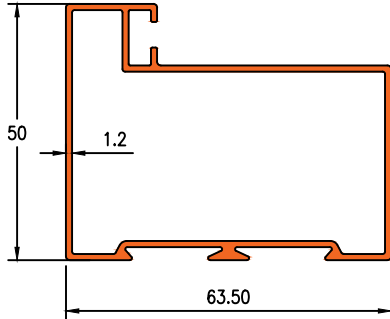

Die No. 1901

0.074 Kg/m

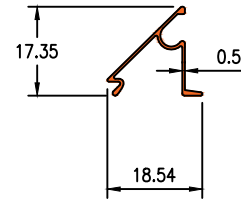

Die No. 1741

0.573 Kg/m
0.846 kg/m

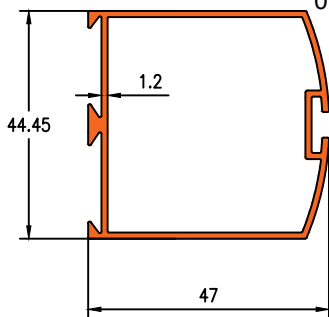

Die No. 2601

0.573 Kg/m

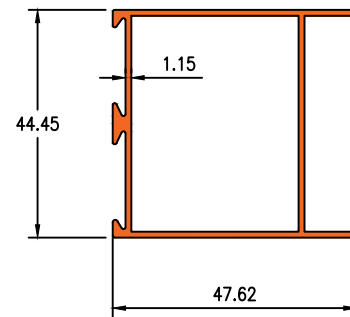

Die No. 1761

0.628 Kg/m

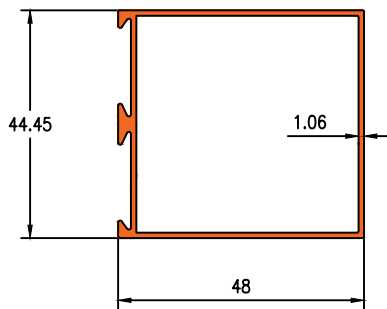

Die No. 2751

0.819 Kg/m

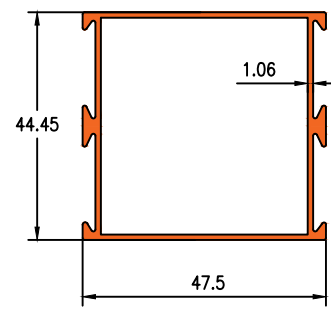

Die No. 1773

2.076 Kg/m

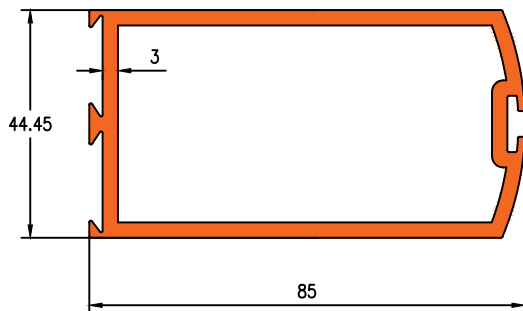

Die No. 1770

1.120 Kg/m

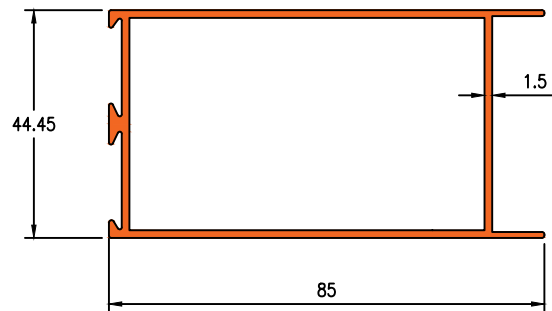



Darshan Extrusions Pvt. Ltd.

Die No. 1775

1.010 Kg/m

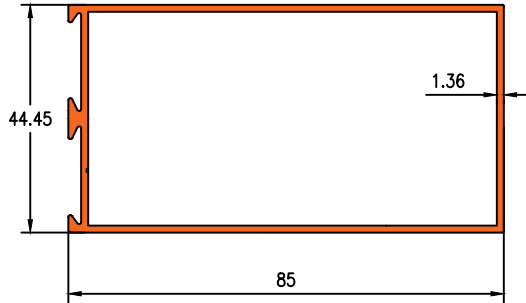

Die No. 1778

1.065 Kg/m

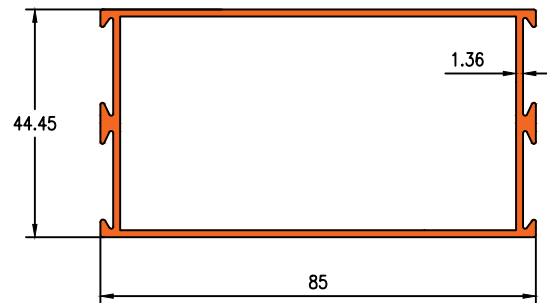

Die No. 1181

1.393 Kg/m

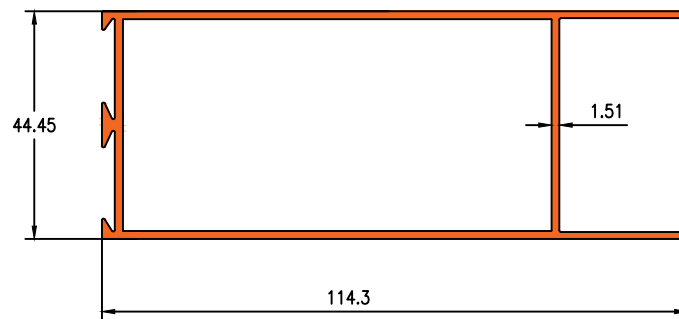



Darshan Extrusions Pvt. Ltd.

Die No. 16082

0.503Kg/m

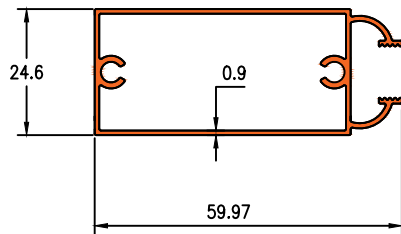

Die No.19361

0.475Kg/m

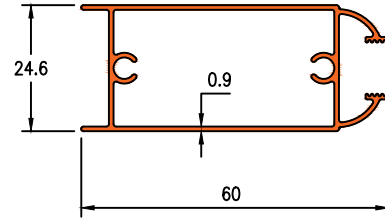

Die No. 16083

0.530Kg/m

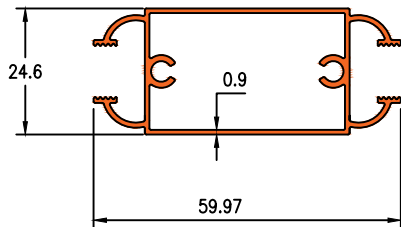

Die No. 16084

0.579Kg/m

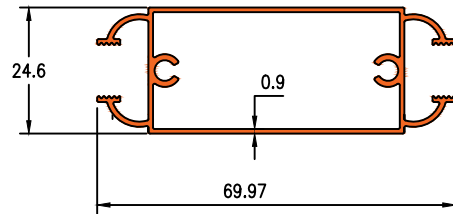

Die No. 16085

0.600Kg/m

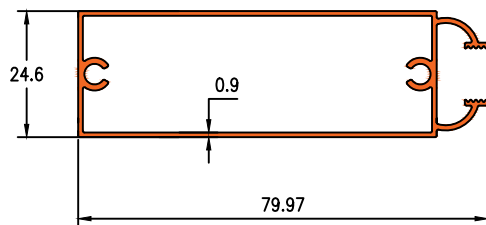



Darshan Extrusions Pvt. Ltd.

Die No. 16087

0.430 Kg/m

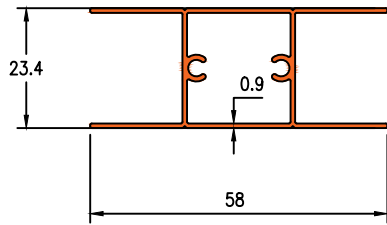

Die No. 16088

0.335 Kg/m

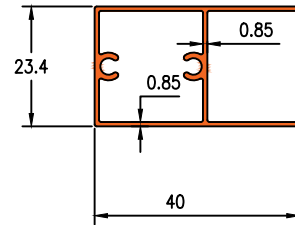

Die No. 21012

0.403 Kg/m

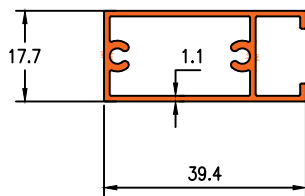

Die No. 5228

1.606 Kg/m

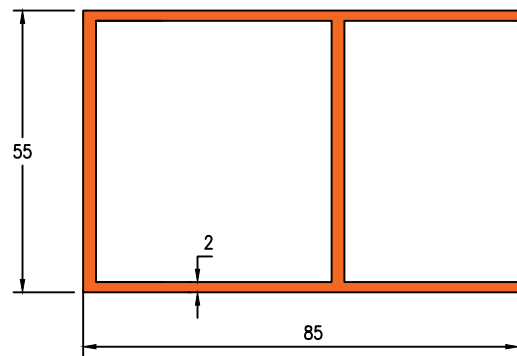

Die No. 21013

0.990 Kg/m

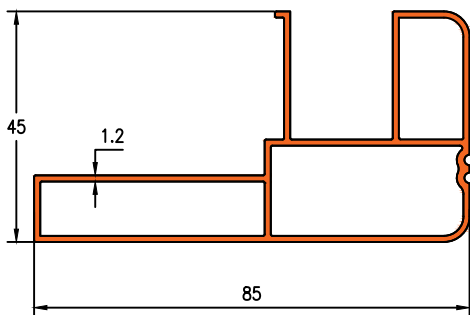

Die No. 7048

0.635 Kg/m

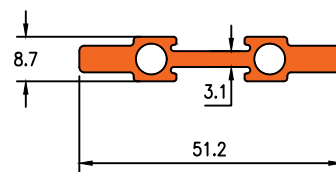

Die No. 7049

0.222 Kg/m

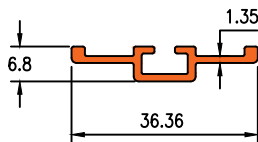

Die No. 7050

0.306 Kg/m

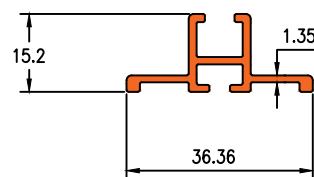



Darshan Extrusions Pvt. Ltd.

Die No. 7017

0.367 Kg/m

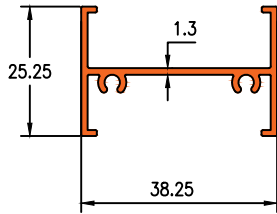

Die No. 7018

0.367 Kg/m

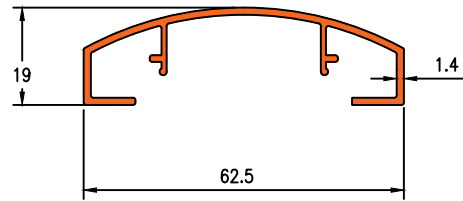

Die No. 7019

0.595 Kg/m

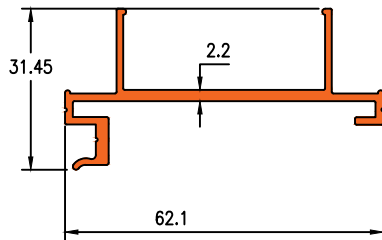

Die No. 7020

0.506 Kg/m

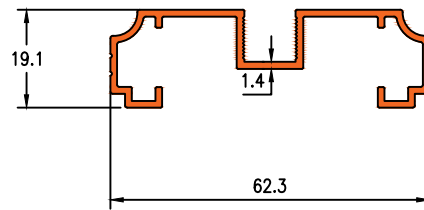

Die No. 7021

0.594 Kg/m

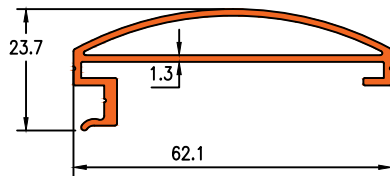

Die No. 7022

1.453 Kg/m

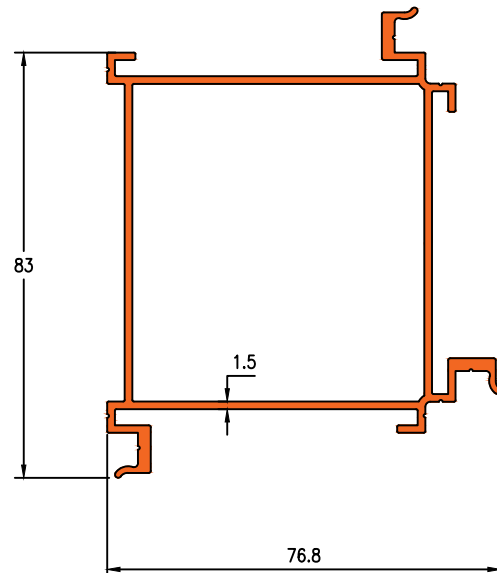

Die No. 7023

1.116 Kg/m

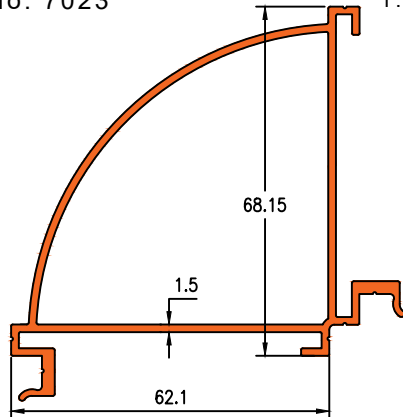



Darshan Extrusions Pvt. Ltd.

Die No. 19613

1.595 Kg/m

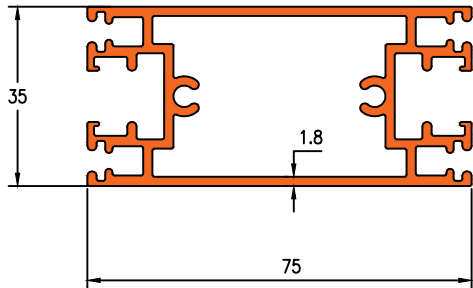

Die No. 19954

0.600 Kg/m

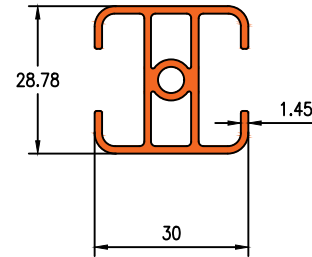

Die No. 19628

1.111 Kg/m

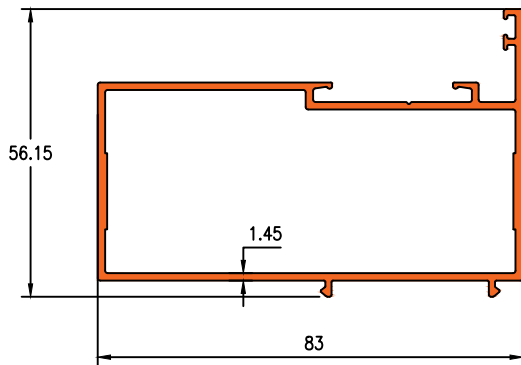

CLIP: 4006 & 4007

Die No. 19629

0.985 Kg/m

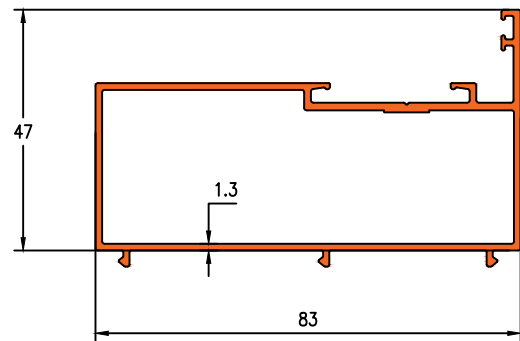

CLIP: 4006 & 4007

Die No. 19631

1.366 Kg/m

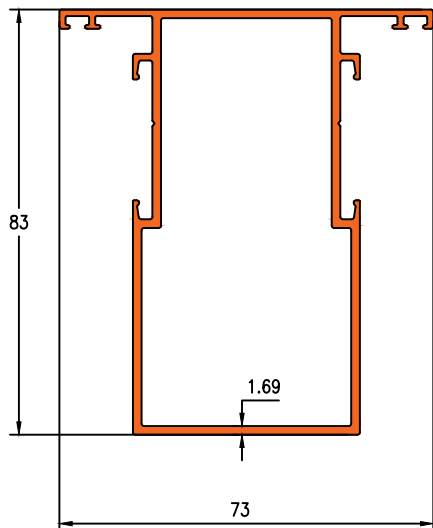

CLIP: 4006 & 4007

Die No. 19630

1.020 Kg/m

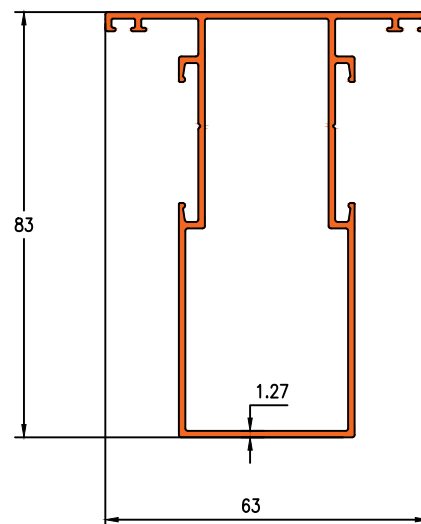

CLIP: 4006 & 4007



Darshan Extrusions Pvt. Ltd.

Die No. 1268

0.412 Kg/m

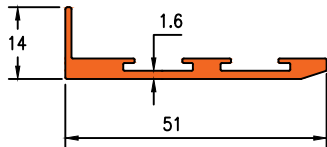

Die No. 19739

0.347 Kg/m

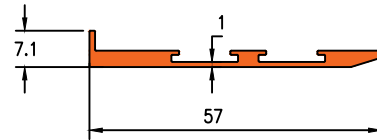

Die No. 19740

0.292 Kg/m

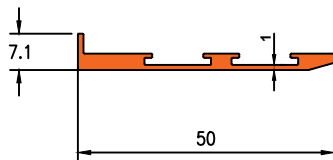

Die No. 23019

0.534 Kg/m

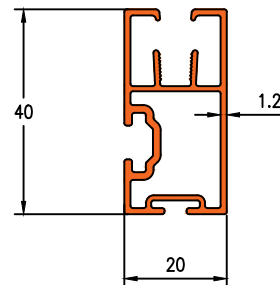

Die No. 16086

0.710 Kg/m

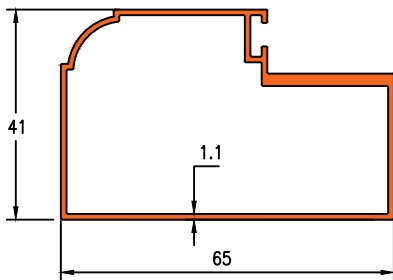

Die No. 16185

0.623 Kg/m

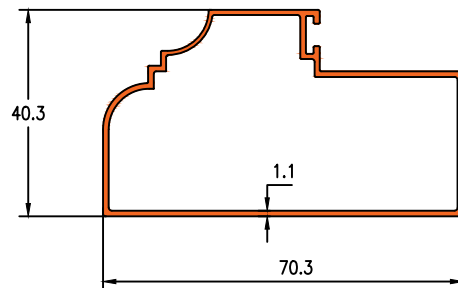

Die No. 10139

0.691 Kg/m

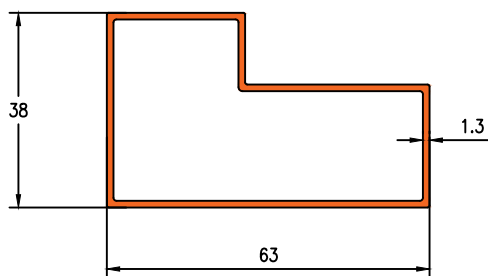

Die No. 10140

0.769 Kg/m

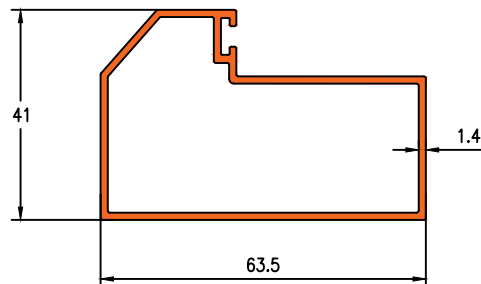



Die No. 19815

2.208 Kg/m

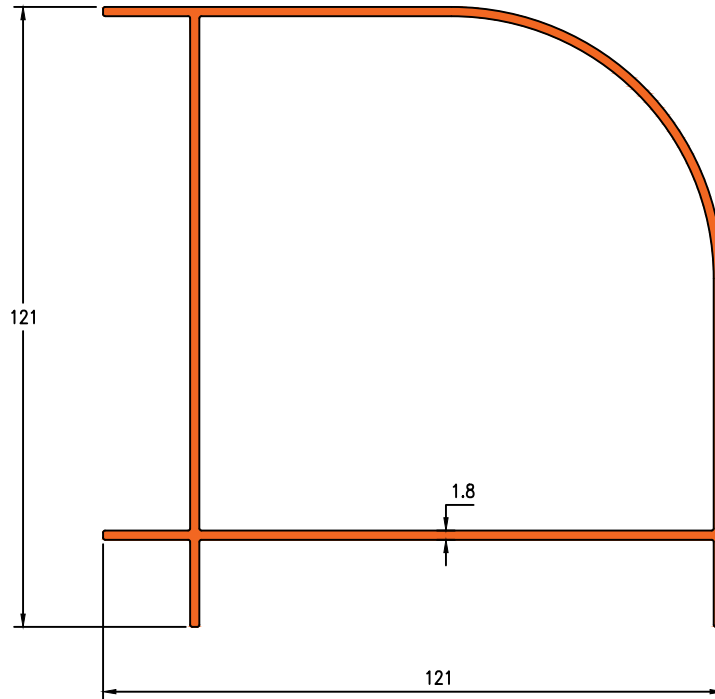

Die No. 19814

1.320 Kg/m

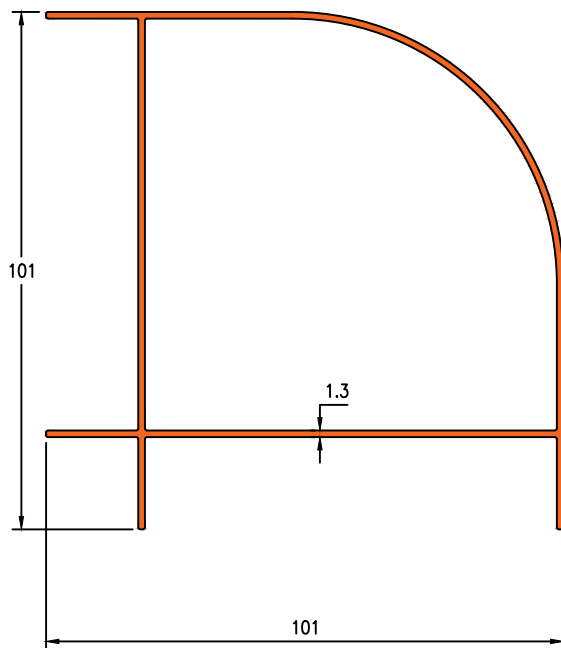

Die No. 19813

0.899 Kg/m

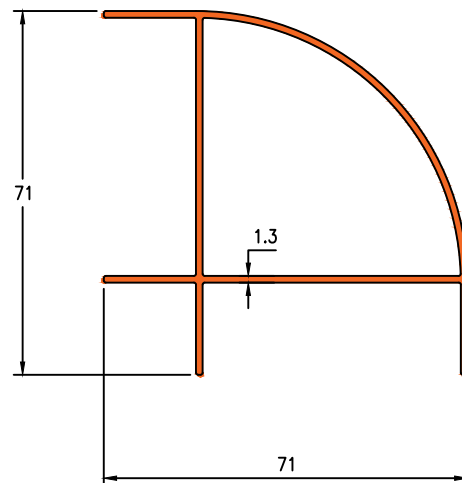



Die No. 16045

0.498 Kg/m

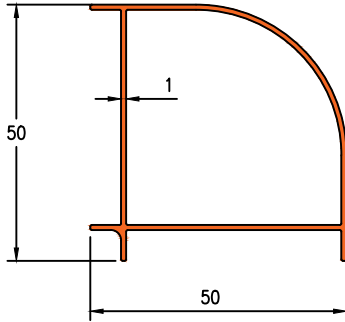

Die No. 16252

4.461 Kg/m

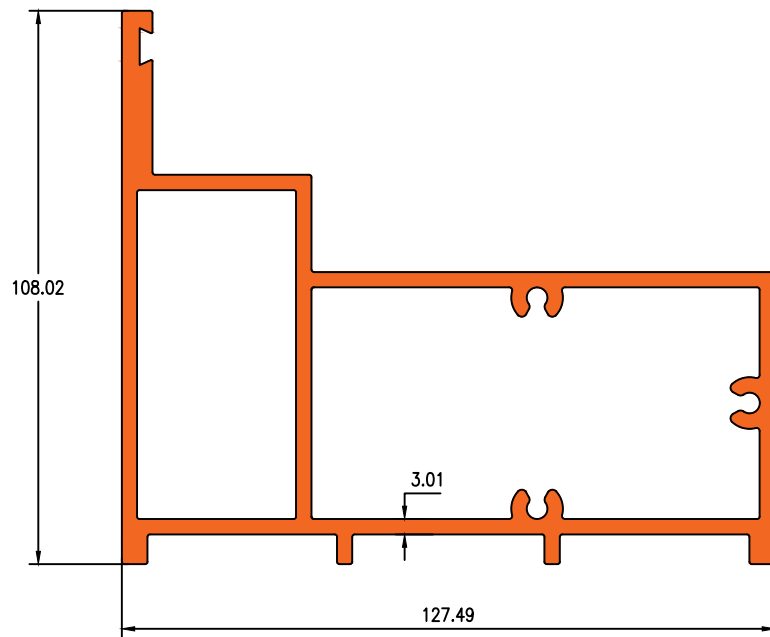

Die No. 16068

1.486 Kg/m

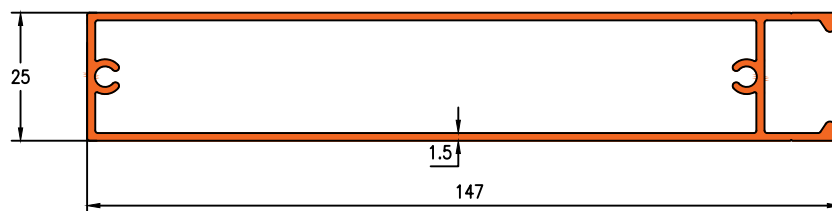



Darshan Extrusions Pvt. Ltd.

Die No.22031

0.491KG/M

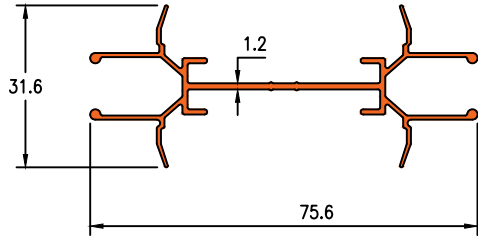

Die No. 22032

0.282KG/M

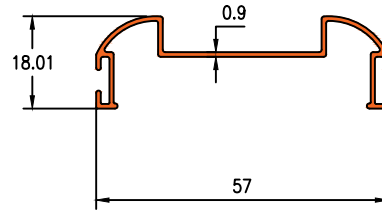

Die No. 22033

0.223 KG/M

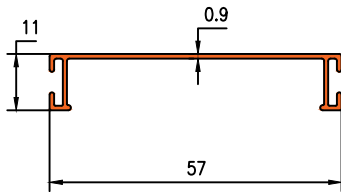

Die No. 22034

0.150 KG/M

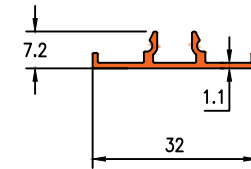

Die No. 22035

0.153 KG/M

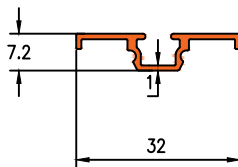

Die No. 22036

1.182 KG/M

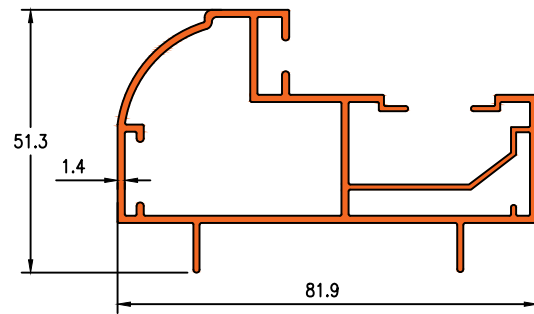



Die No.22037

1.663 KG/M

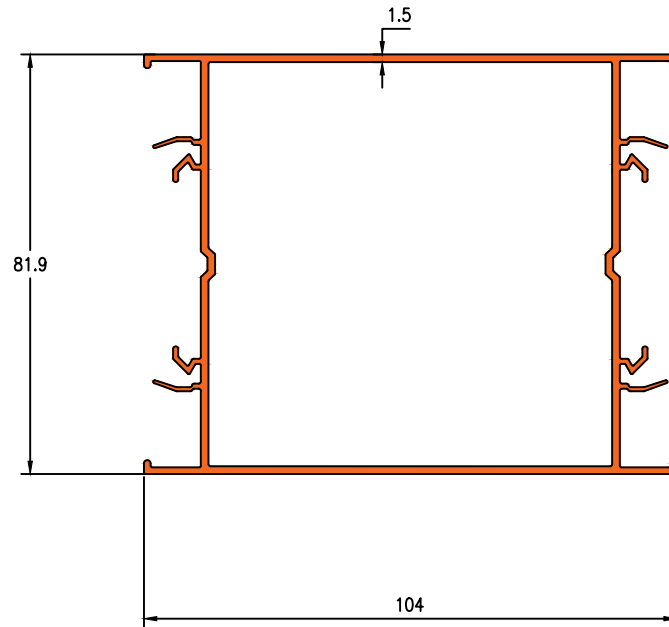

Die No. 22038

1.568 KG/M

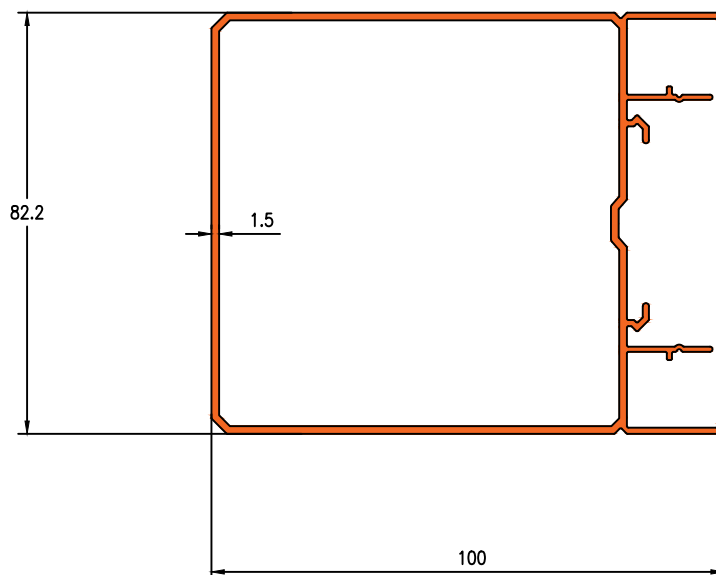



Darshan Extrusions Pvt. Ltd.

Die No.22039

1.301 KG/M

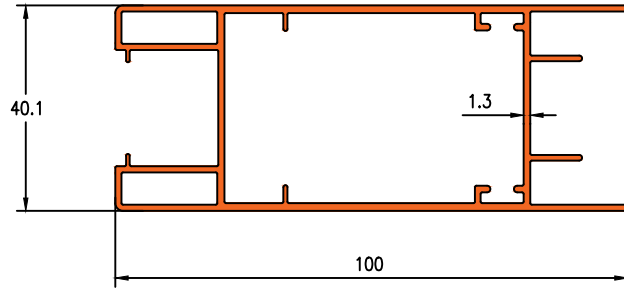

Die No. 22040

0.970KG/M

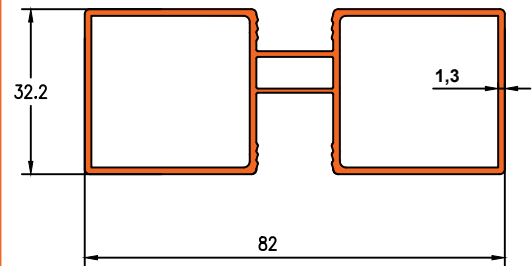

Die No. 22041

0.859 KG/M

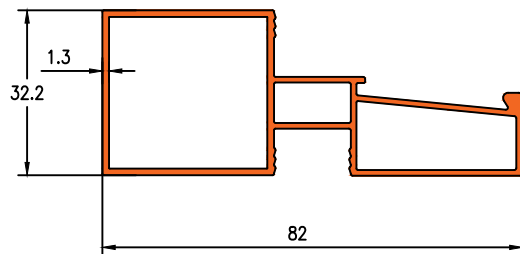

Die No. 22042

0.227KG/M

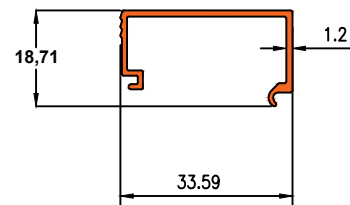

Die No. 22043

1.264 KG/M

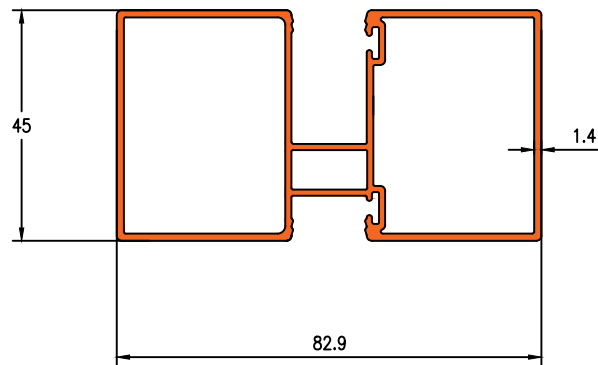



Darshan Extrusions Pvt. Ltd.

Die No.7045

1.543Kg/m

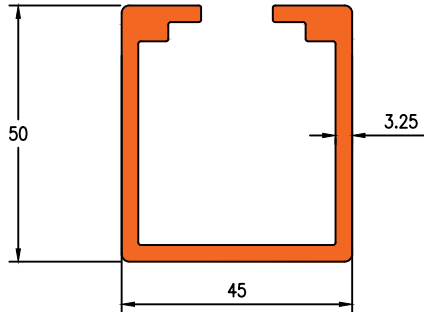

Die No.19830

0.599Kg/m

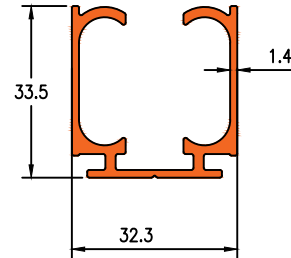

Die No.7044

1.174Kg/m

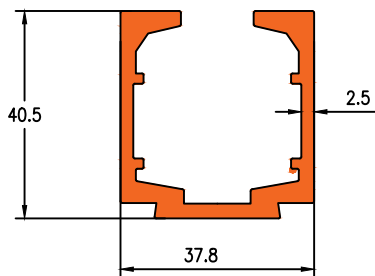

Die No.7062

0.961Kg/m

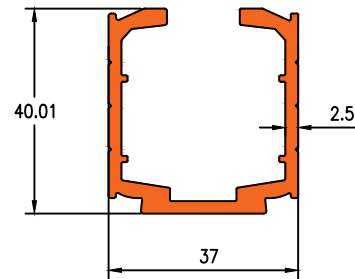

Die No.7042

1.778Kg/m

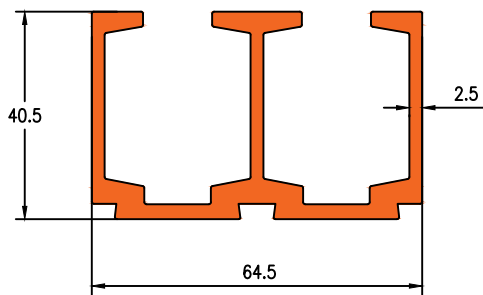

Die No.7043

1.468Kg/m

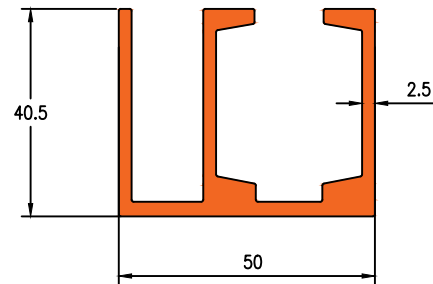

Die No.7063

1.357Kg/m

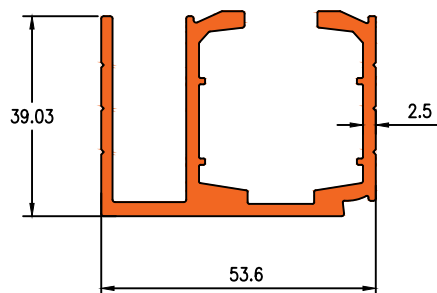

Die No.7064

1.736Kg/m

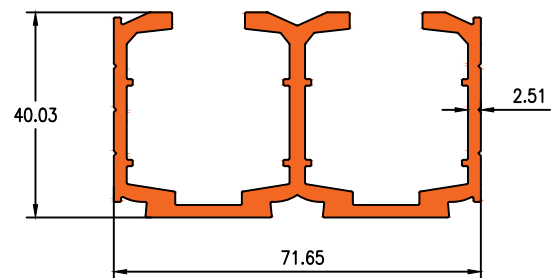



Darshan Extrusions Pvt. Ltd.

Die No.19838

0.767Kg/m

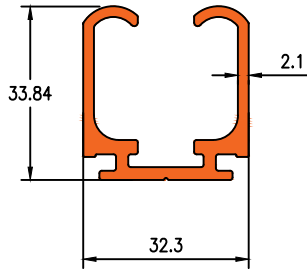

Die No.19948

1.362Kg/m

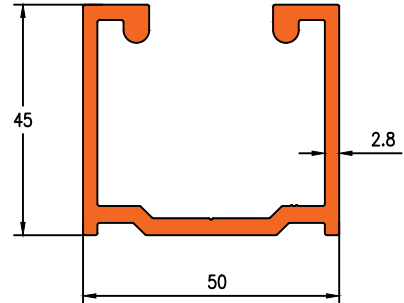

Die No.1296

0.552Kg/m

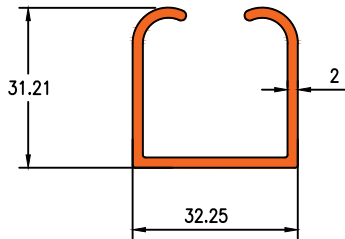

Die No.19837

1.818Kg/m

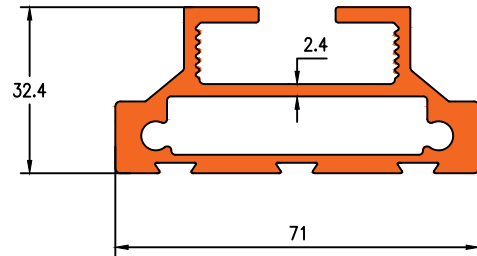

Die No.19658

0.621Kg/m

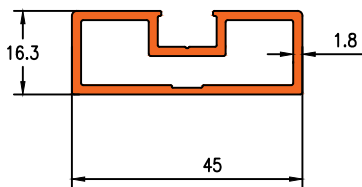

Die No.19657

0.790Kg/m

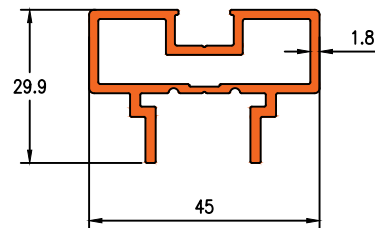

Die No.20053

0.631Kg/m

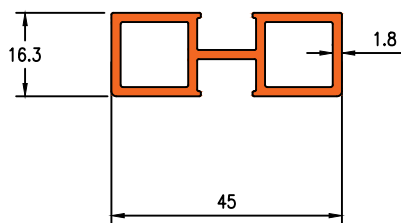

Die No.23159

0.751 Kg/m

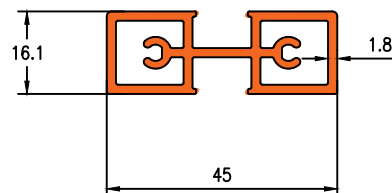



Darshan Extrusions Pvt. Ltd.

Die No.23130

0.564 Kg/m

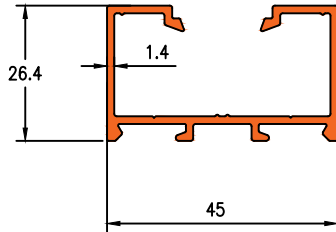

CLIP - 23133

Die No.23131

0.455 Kg/m

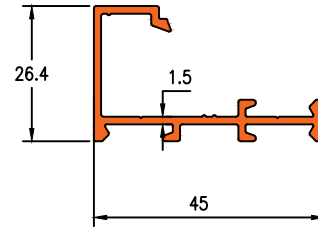

CLIP - 23132

Die No.23132

0.169 Kg/m

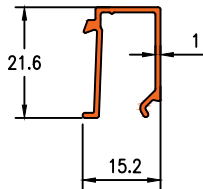

Die No.23133

0.203 Kg/m

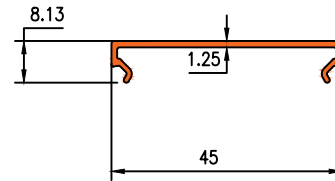

Die No.23115

0.568 KG/M

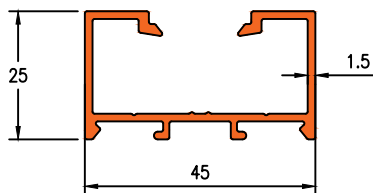

CLIP - 23101

Die No.23116

0.457 KG/M

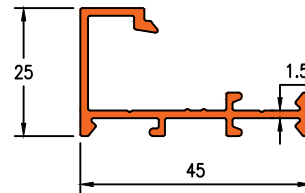

CLIP - 23117

Die No.23117

0.164 KG/M

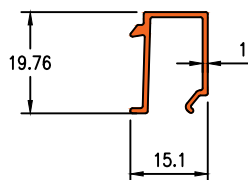

Die No.23101

0.265 KG/M

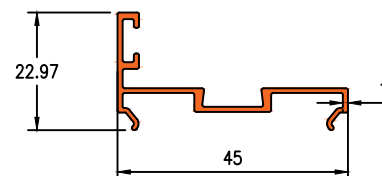



Darshan Extrusions Pvt. Ltd.

Die No.23102

0.169 Kg/m

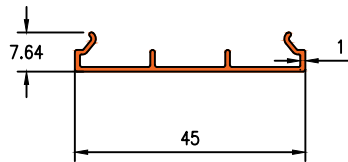

Die No.22052

0.457 KG/M

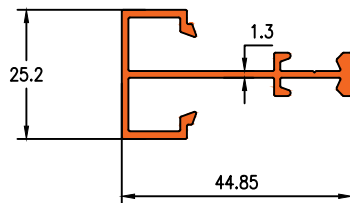

CLIP - 22053

Die No.22053

0.122 KG/M

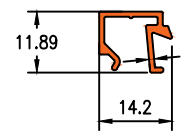



Darshan Extrusions Pvt. Ltd.

Die No.23134

1.050 KG/M

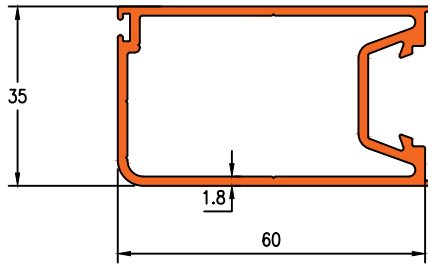

Die No.22051

1.053 KG/M

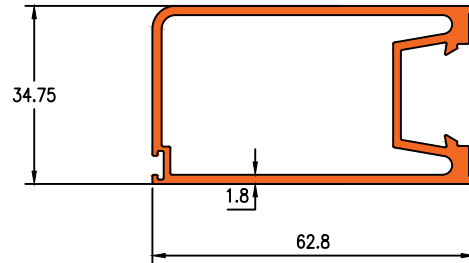

Die No.16590

1.059 KG/M

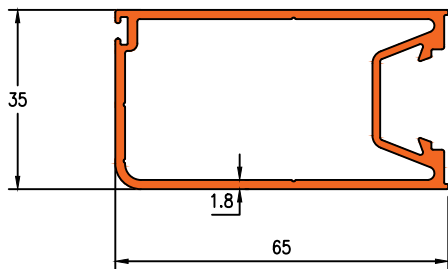

Die No.22050

1.233 KG/M

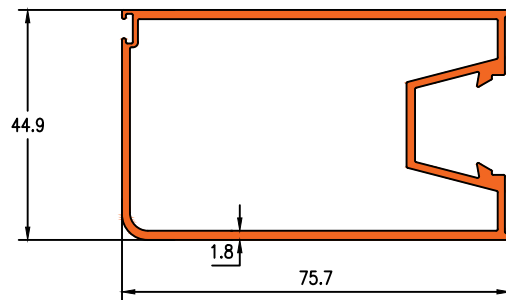

Die No.22083

0.773 KG/M

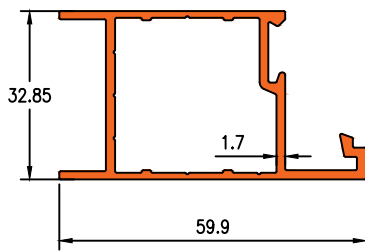

Die No.22084

0.177 KG/M

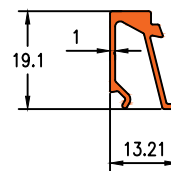

Die No.23149

0.871 KG/M

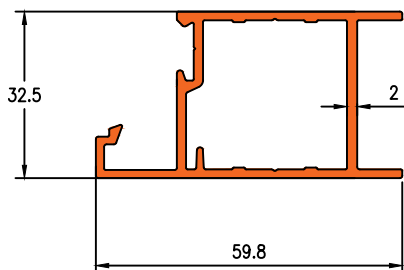

Die No.23150

0.177 KG/M

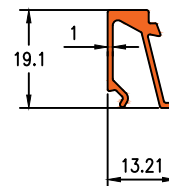



Darshan Extrusions Pvt. Ltd.

Die No.22059

1.073 KG/M

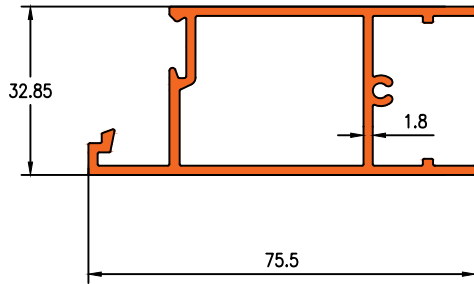

Die No.22060

0.177 KG/M

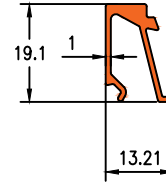

Die No.23135

1.214KG/M

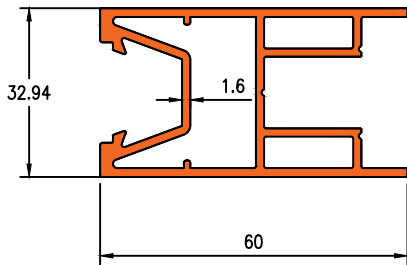

Die No.16510

1.535KG/M

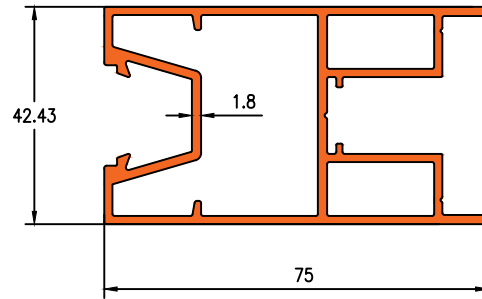

Die No.22045

1.465 KG/M

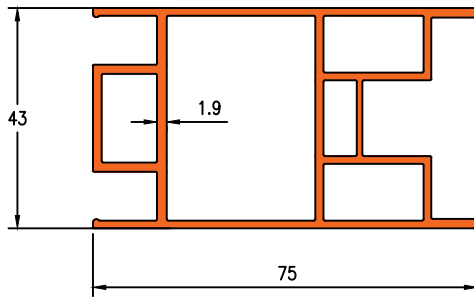

Die No.16494

1.841KG/M

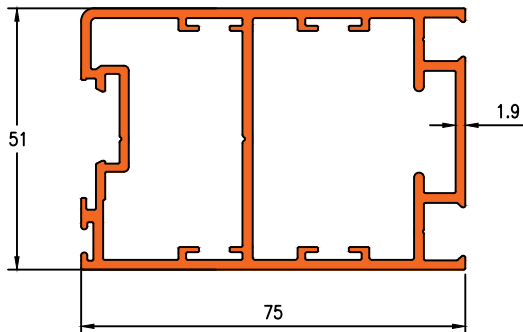

Die No.16495

1.923KG/M

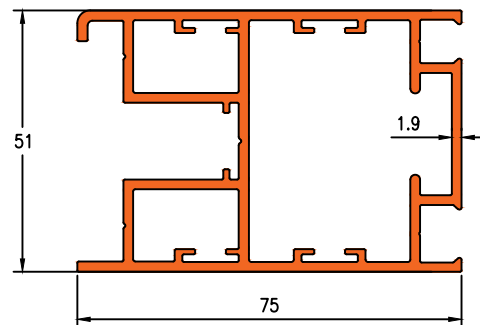



Darshan Extrusions Pvt. Ltd.

Die No.23136

1.006 KG/M

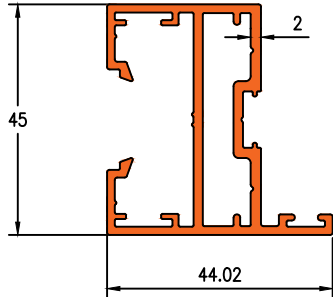

Die No.22078

0.988 KG/M

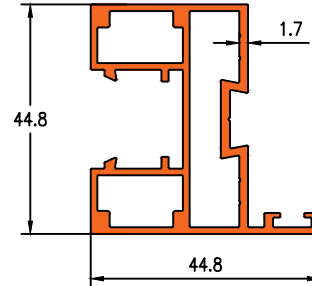

Die No.23148

1.006 KG/M

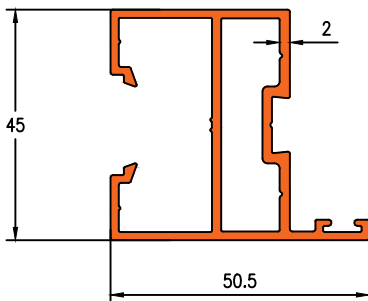

Die No.22071

0.063 KG/M

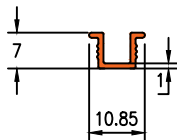

Die No.22080

0.078 KG/M

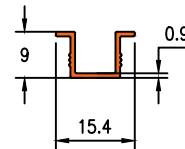

Die No.23138

0.171 KG/M

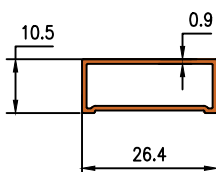

Die No.22079

0.179 KG/M

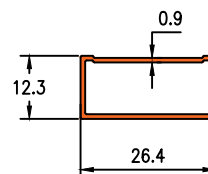



Darshan Extrusions Pvt. Ltd.

Die No.23137

0.199KG/M

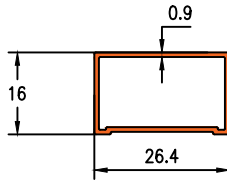

Die No.13000

0.140Kg/m

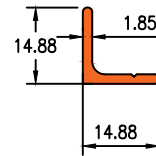

Die No.22062

0.163 KG/M

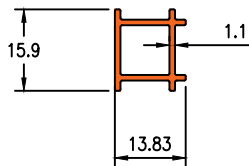

Die No.22061

0.192 KG/M

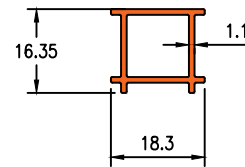

Die No.22068

0.160 KG/M

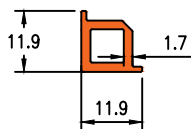

Die No.22067

0.207 KG/M

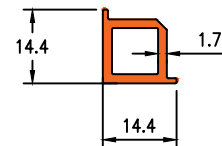

Die No.22069

0.086 KG/M

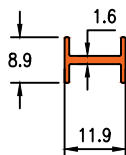

Die No.22070

0.097 KG/M

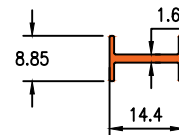



Darshan Extrusions Pvt. Ltd.

Die No.22075

0.143 KG/M

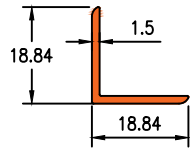

Die No.22074

0.190 KG/M

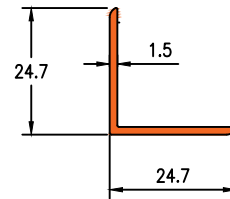

Die No.22065

1.465 KG/M

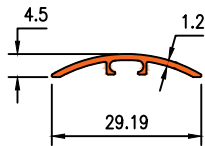

Die No.22066

0.216 KG/M

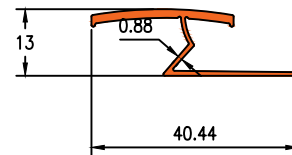

Die No.22064

0.386 KG/M

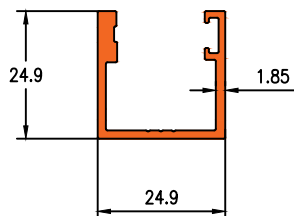

Die No.22057

0.275 KG/M

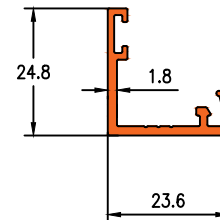

CLIP - 22058

Die No.22058

0.158 KG/M

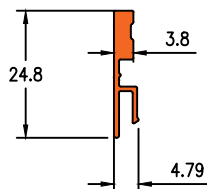



Darshan Extrusions Pvt. Ltd.

Die No.22056

0.476 KG/M

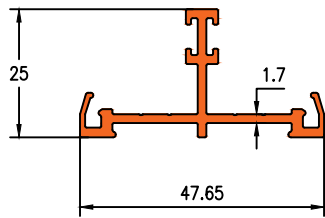

CLIP - 22055

Die No.22054

0.720 KG/M

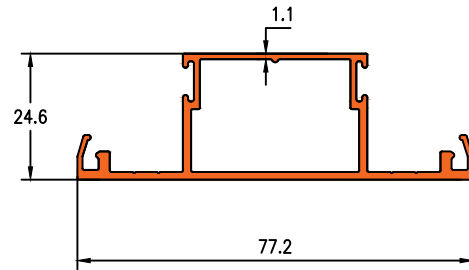

CLIP - 22055

Die No.22055

0.135 KG/M

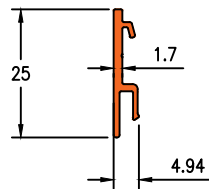

Die No.22081

0.644 KG/M

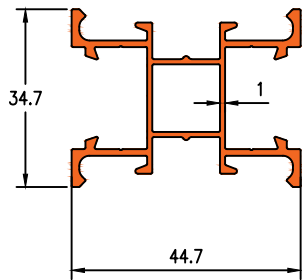

Die No.22082

0.076 KG/M

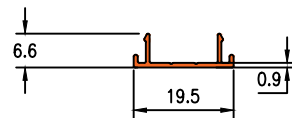



Darshan Extrusions Pvt. Ltd.

Die No.16467

0.966 Kg/m

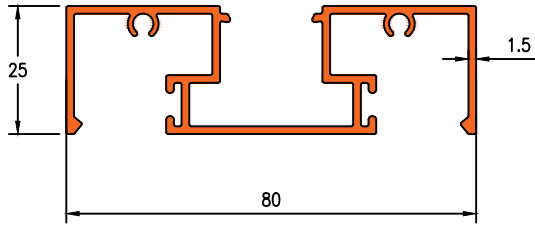

Die No.16468

0.713 Kg/m

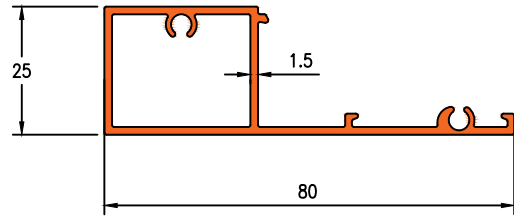

Die No.16469

0.373 Kg/m

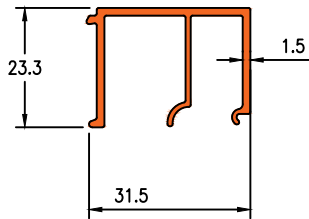

Die No.16470

0.364 Kg/m

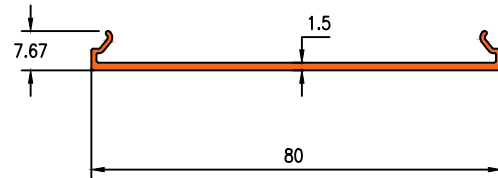

Die No.16471

0.456 Kg/m

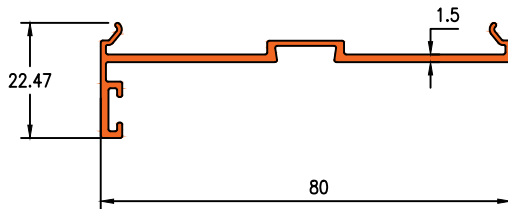

Die No.22085

0.738 Kg/m

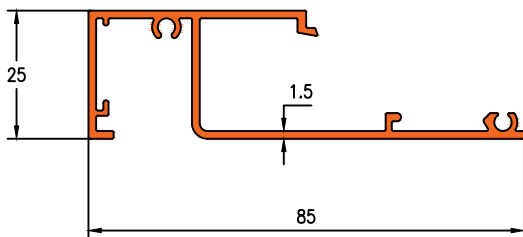

Die No.22086

0.352Kg/m

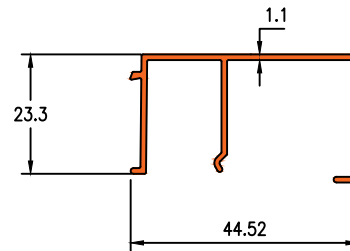



Darshan Extrusions Pvt. Ltd.

Die No.21167

1.078KG/M

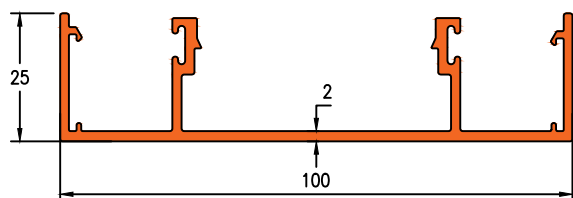

Die No.21166

0.186KG/M

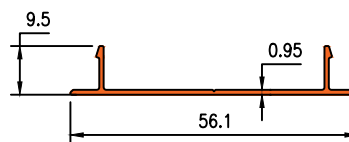

Die No.22049

1.465 KG/M

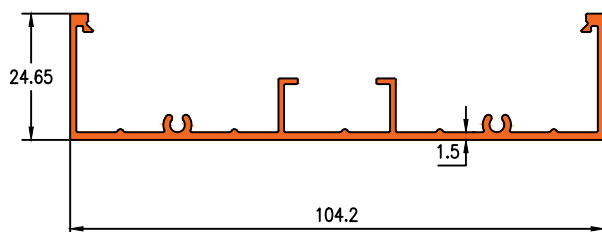

Die No.22048

0.558 KG/M

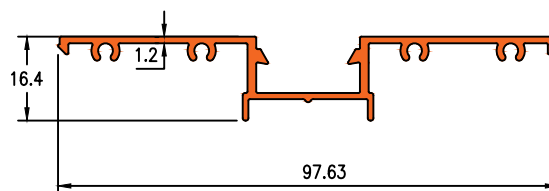

Die No.22046

1.162 KG/M

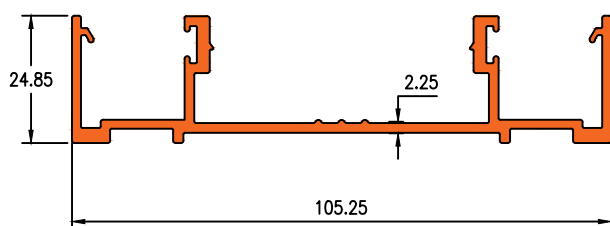

Die No. 23140

1.678 KG/M

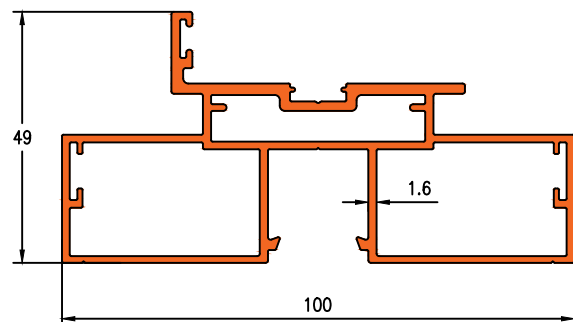

Die No.22047

1.333 KG/M

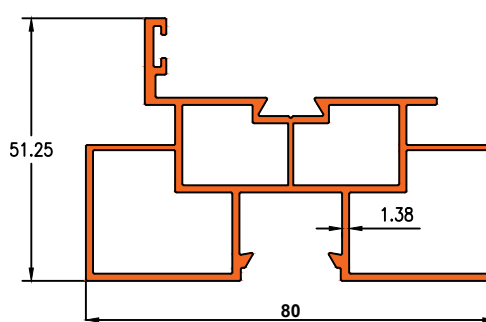



Darshan Extrusions Pvt. Ltd.

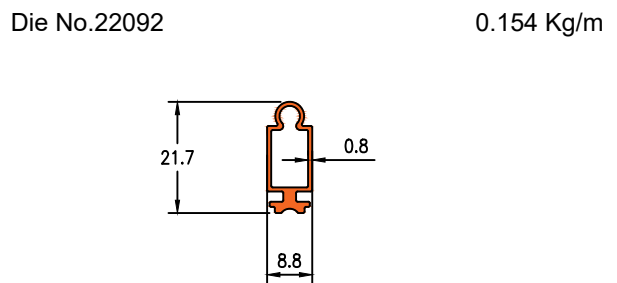
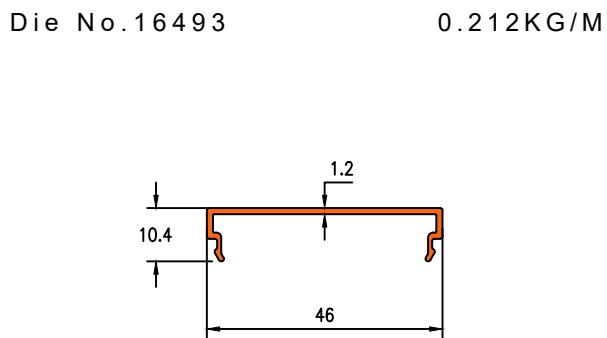
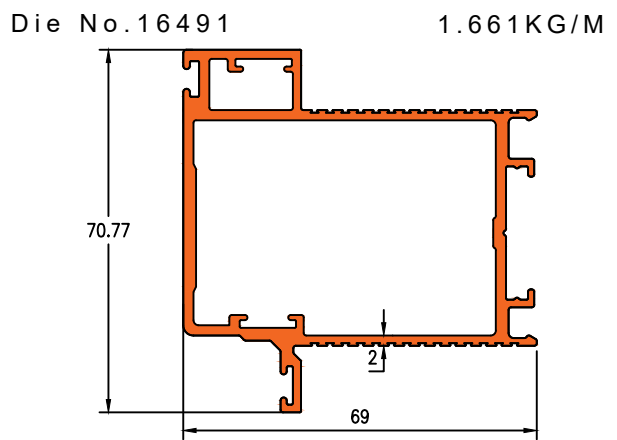
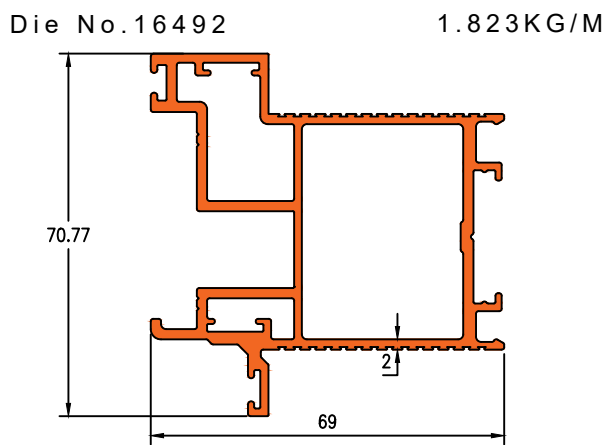
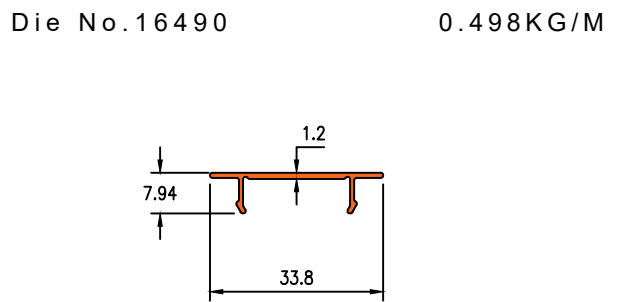
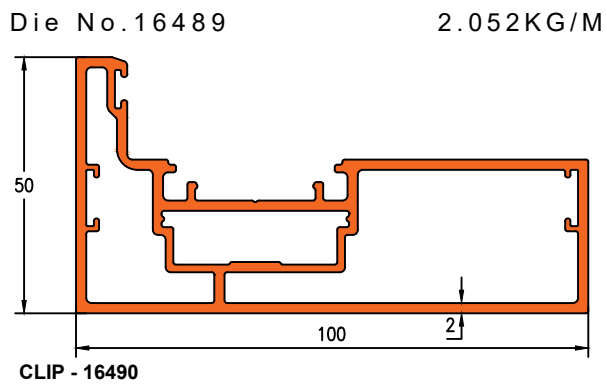
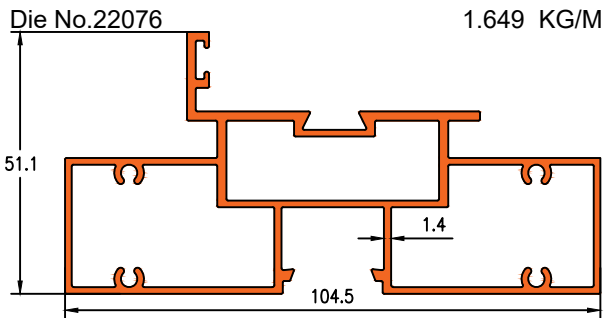



Darshan Extrusions Pvt. Ltd.

Die No.22087

0.943 Kg/m

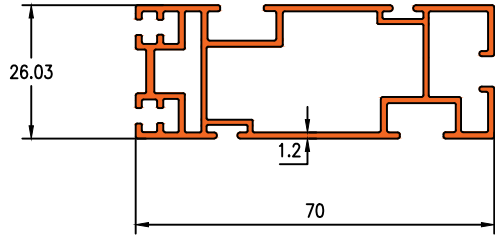

Die No.22088

1.135Kg/m

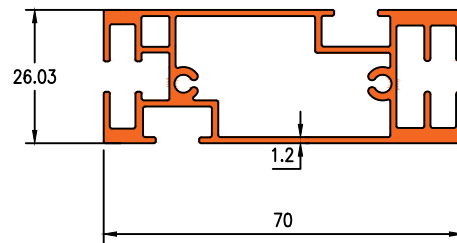

Die No.22089

0.258 Kg/m

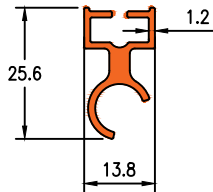

Die No.22090

0.204Kg/m

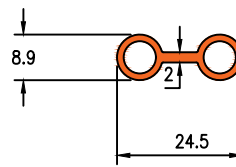

Die No.22091

0.889Kg/m

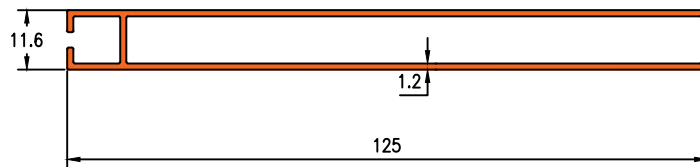

Die No.28048

0.621Kg/m

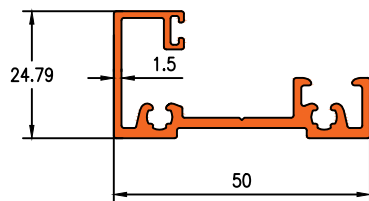

Die No.28049

0.177Kg/m

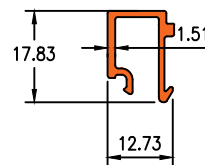



Darshan Extrusions Pvt. Ltd.

Die No.19159

0.203 Kg/m

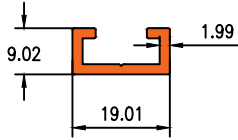

Die No.19160

1.286Kg/m

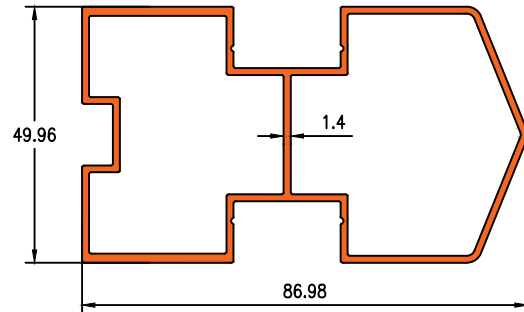

Die No.19161

0.110 Kg/m

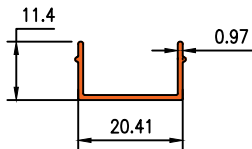

Die No.19162

0.909 Kg/m

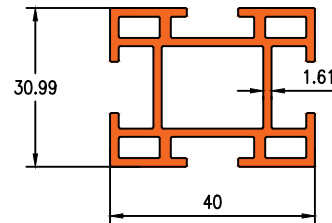

Die No.19163

0.205 Kg/m

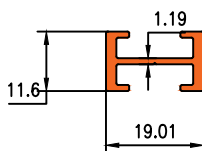



Darshan Extrusions Pvt. Ltd.

Die No.16652

0.730 Kg/m

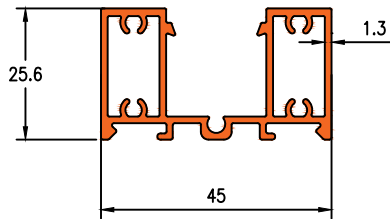

Die No.16653

0.090 Kg/m

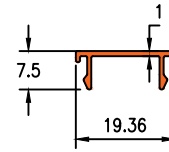

Die No.16654

0.701 Kg/m

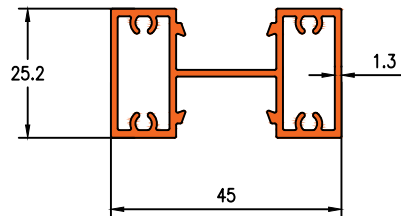

Die No.16655

0.501 Kg/m

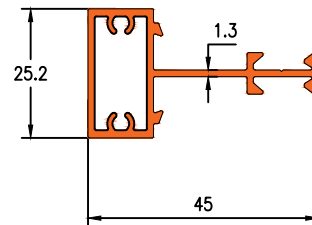

Die No.16656

0.132 Kg/m

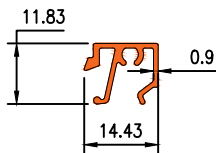

Die No.16657

1.019 Kg/m

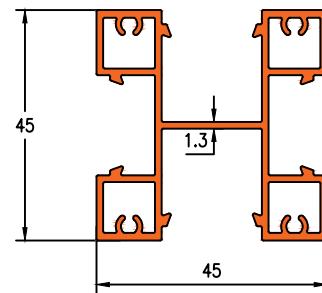

Die No.16658

0.706 Kg/m

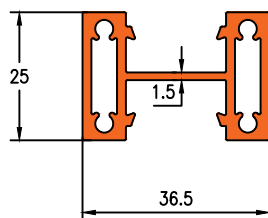



Darshan Extrusions Pvt. Ltd.

Die No.23151

0.478 Kg/m

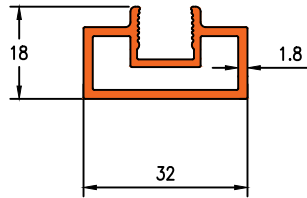

Die No.23152

0.655 Kg/m

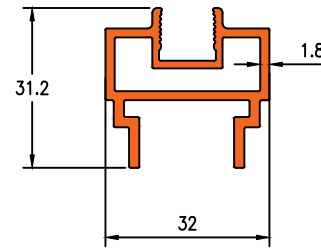

Die No.23153

0.287 Kg/m

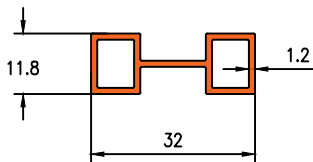

Die No.23154

0.606 Kg/m

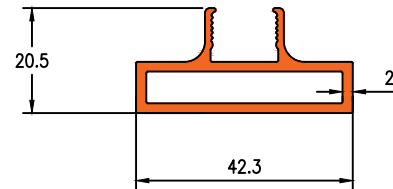

Die No.23155

0.759 Kg/m

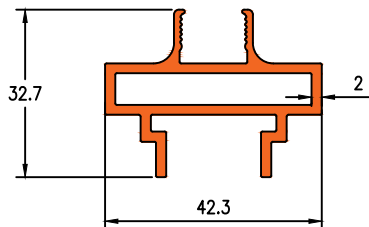

Die No.23156

0.532 Kg/m

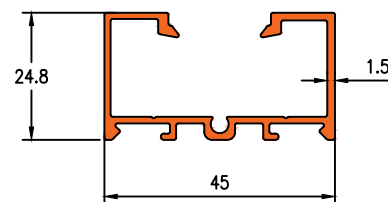

Die No.23157

0.418 Kg/m

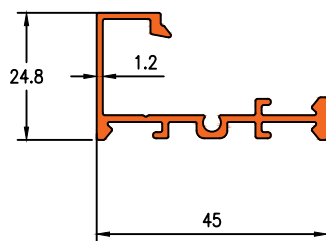

Die No.23158

0.160 Kg/m

