

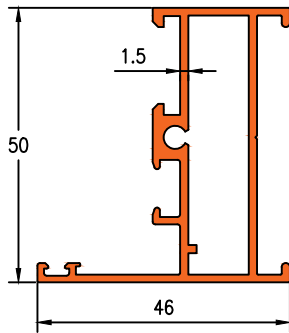

Darshan Extrusions Pvt. Ltd.

Die No. 5001

0.807KG/M



Die No. 5002

0.999KG/M

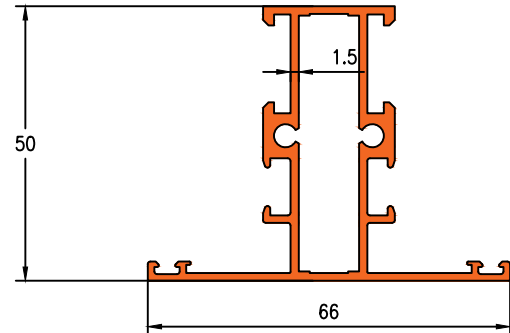

Die No. 5003

1.138KG/M

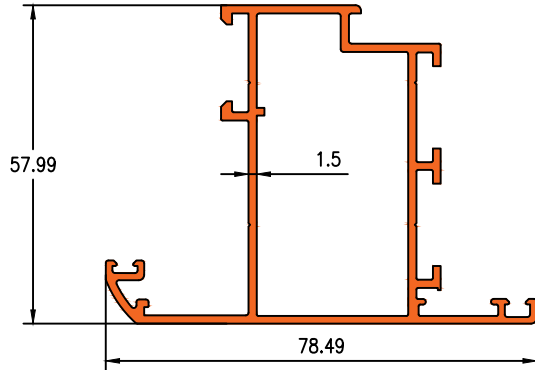

Die No. 5004

0.954KG/M

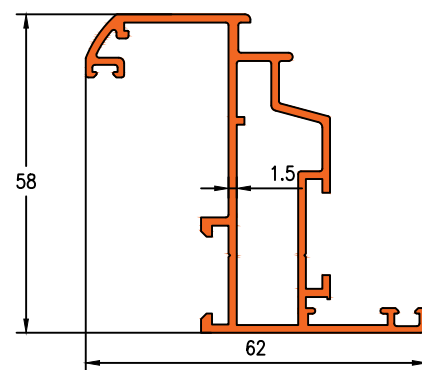

Die No. 5005

1.206KG/M

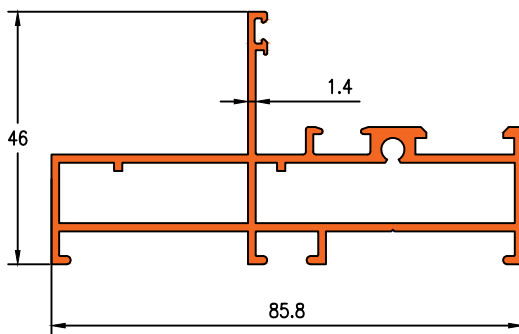

Die No. 5006

0.806KG/M

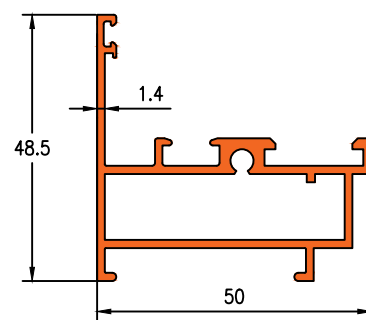

Die No. 5007

1.080KG/M

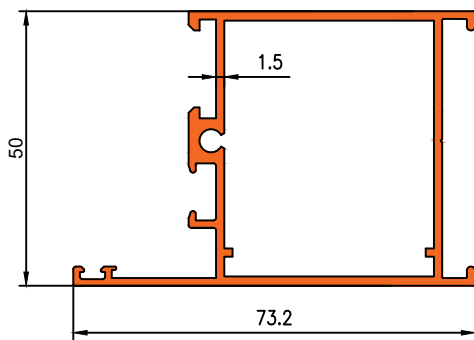

Die No. 5008

1.260KG/M

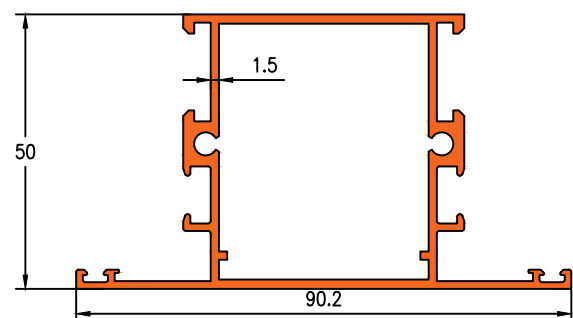

50 MM OPENABLE WINDOW



Darshan Extrusions Pvt. Ltd.

Die No. 5009 1.291KG/M

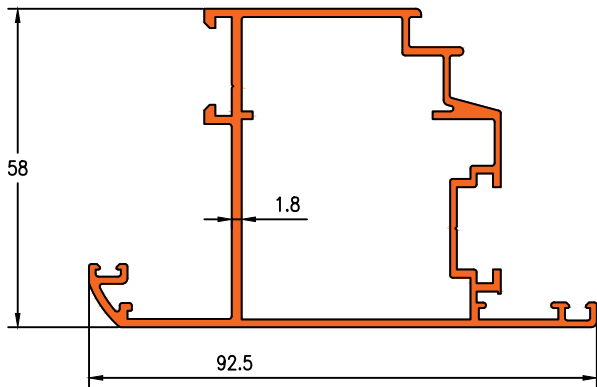

Die No. 5010 0.965KG/M

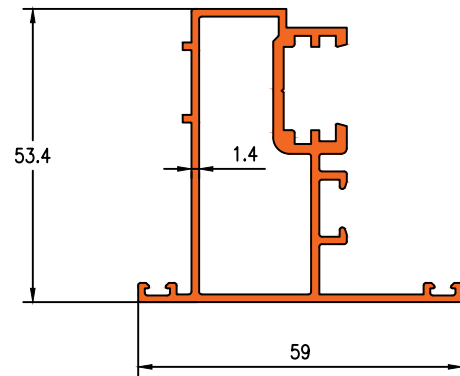

Die No. 5011 2.135KG/M

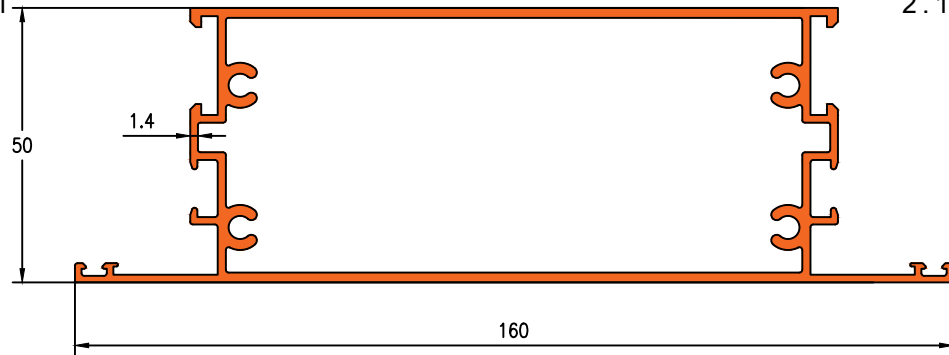

Die No. 5012 2.291KG/M

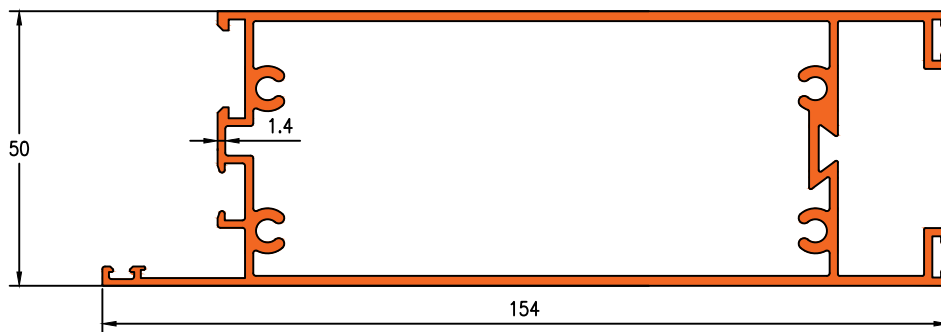

Die No. 16558 1.404KG/M

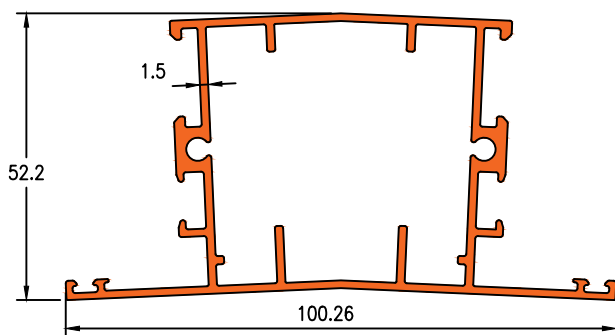

Die No. 5013 0.313KG/M

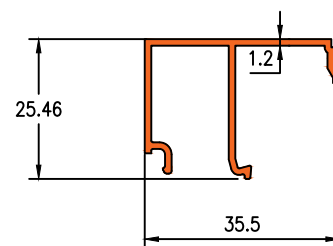

50 MM OPENABLE WINDOW



Darshan Extrusions Pvt. Ltd.

Die No. 5014

0.230KG/M

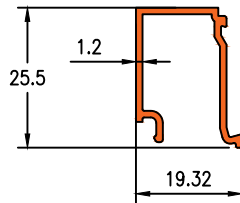

Die No. 5015

0.289KG/M

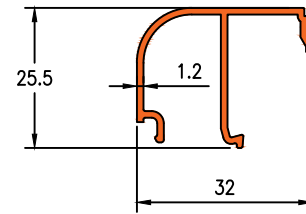

Die No. 5016

0.217KG/M

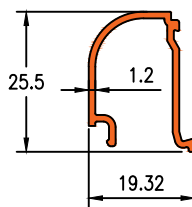

Die No. 5017

0.501KG/M

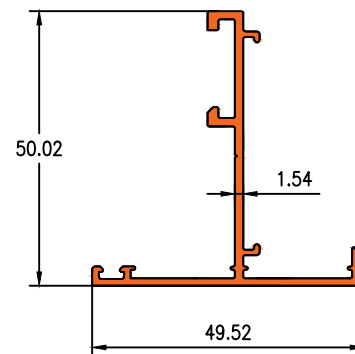

Die No. 5018

0.265KG/M

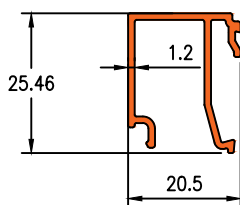

Die No. 16103

0.911KG/M

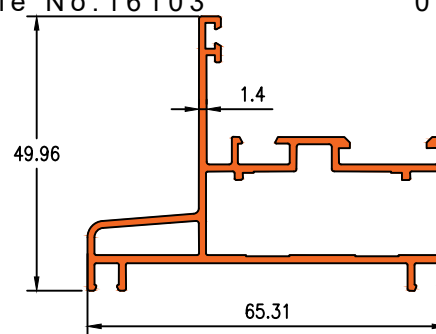

Die No. 5019

0.290KG/M

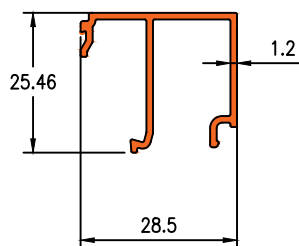

Die No. 16125

0.951KG/M

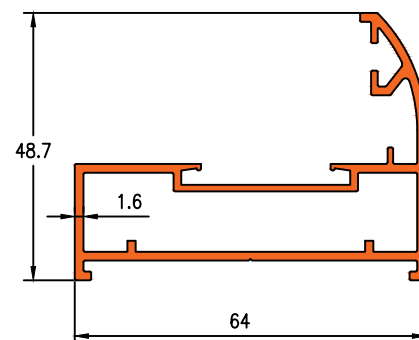



Die No.20045

0.869KG/M

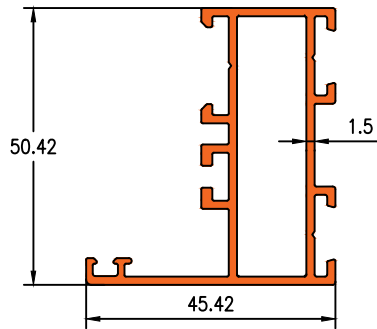

Die No.20047

1.171KG/M

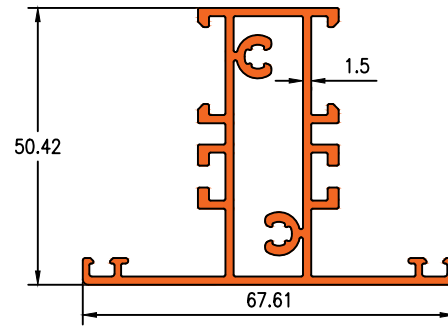

Die No.20049

0.091KG/M

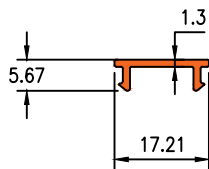

Die No.20050

0.144KG/M

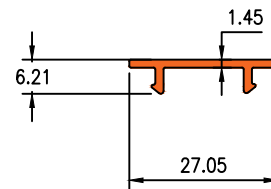

Die No.21023

0.192KG/M

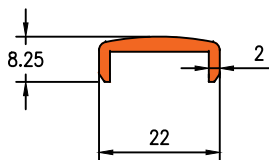

Die No.21024

0.521KG/M

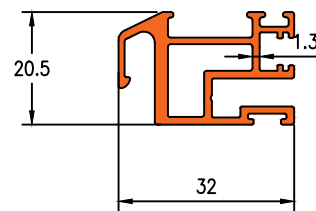

Die No.22018

0.492KG/M

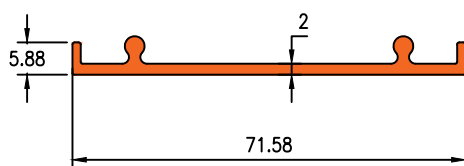

Die No.19674

0.218KG/M

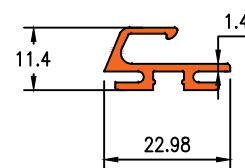



Die No.21021

1.172KG/M

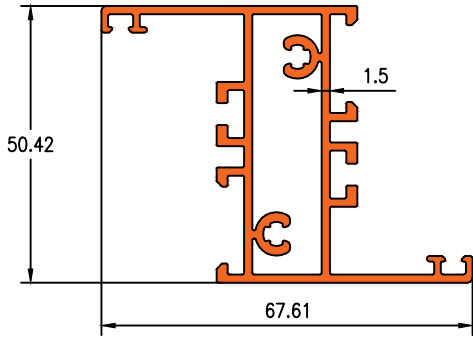

Die No.19974

1.166KG/M

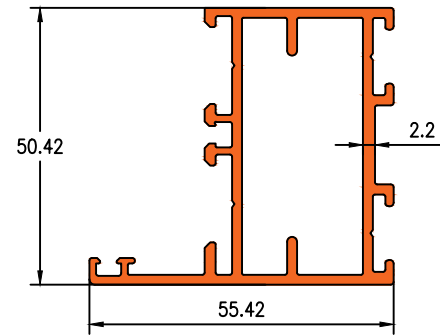

Die No.20046

1.435KG/M

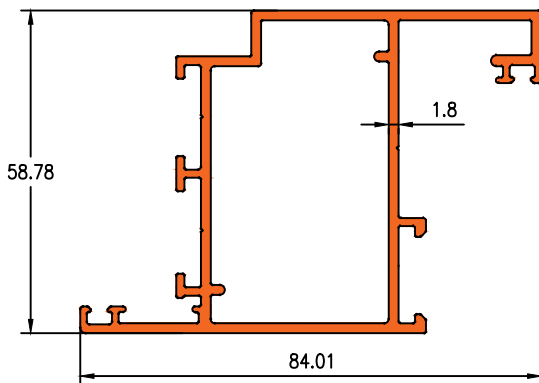

Die No.19973

1.649KG/M

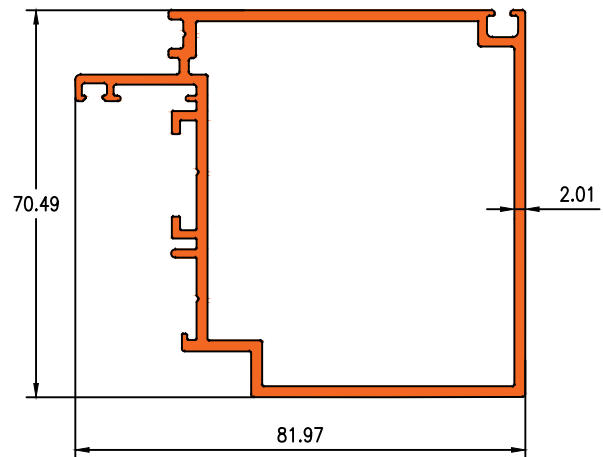

Die No.19664

1.354KG/M

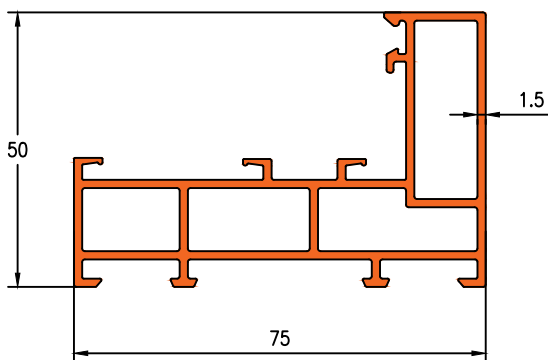

Die No.19665

0.395KG/M

