

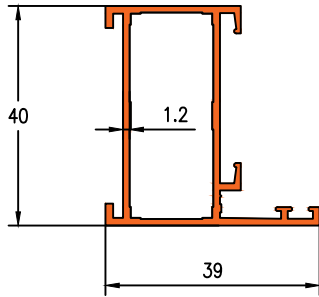

Darshan Extrusions Pvt. Ltd.

Die No. 4001

0.545KG/M



Die No. 4002

0.700KG/M

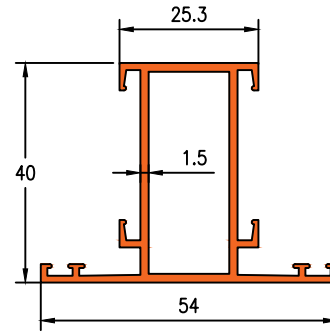

Die No. 4003

0.898KG/M

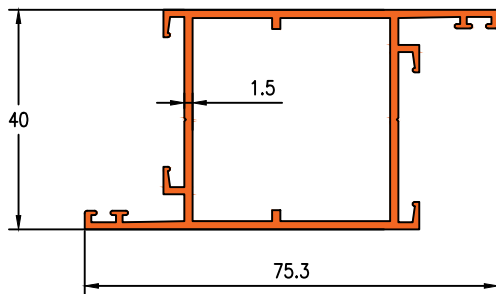

Die No. 4004

0.897KG/M

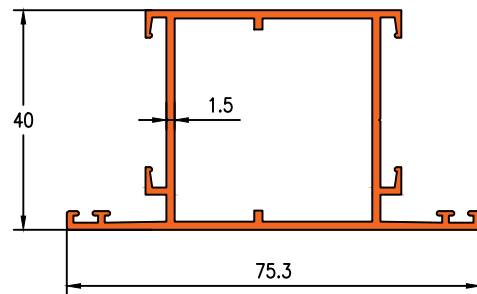

Die No. 4005

1.386KG/M

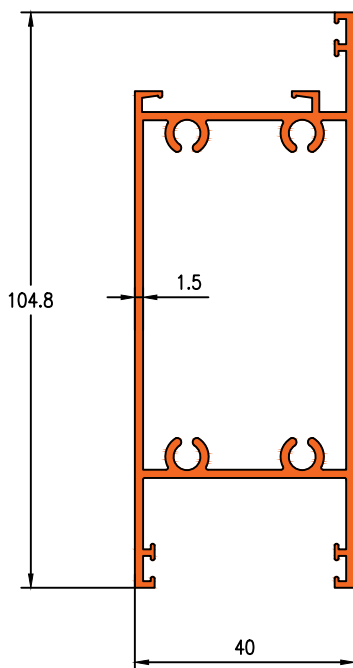

Die No. 16580

0.852KG/M

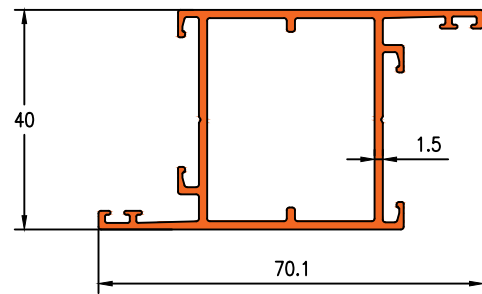

Die No. 16581

0.160KG/M

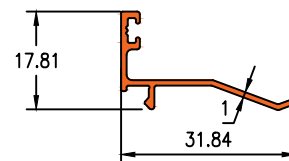

40 MM OPENABLE WINDOW



Darshan Extrusions Pvt. Ltd.

Die No. 4006

0.207KG/M

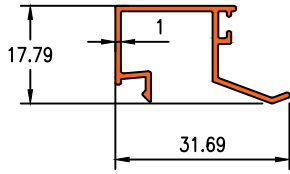

Die No. 4007

0.202KG/M

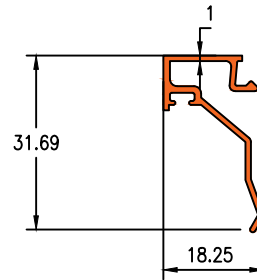

Die No. 16582

1.297KG/M

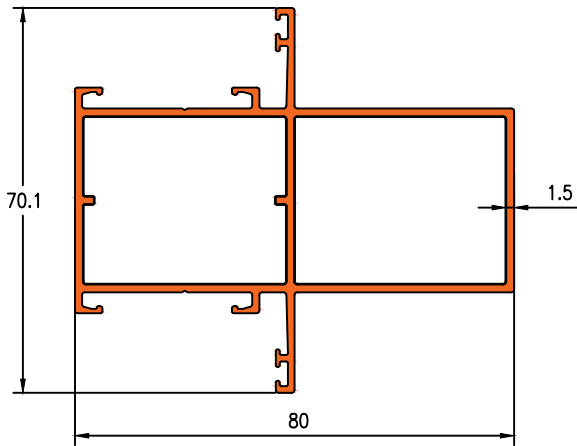

Die No. 16583

0.992KG/M

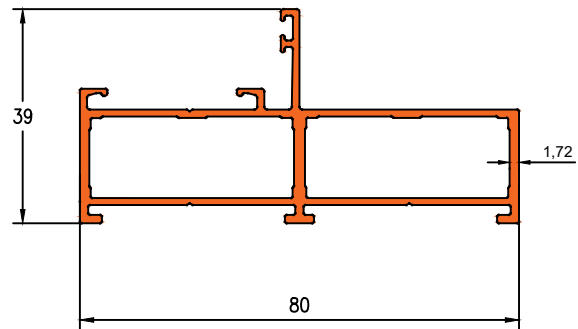

Die No. 4008

0.386KG/M

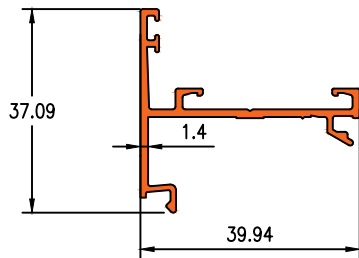

Die No. 4009

0.163KG/M

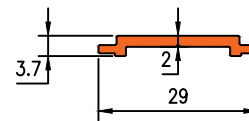

Die No. 4010

0.661KG/M

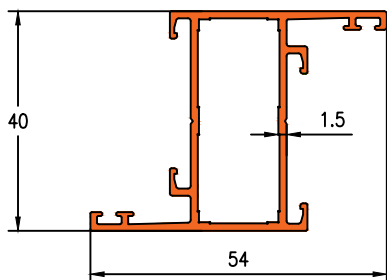

Die No. 4011

0.211KG/M

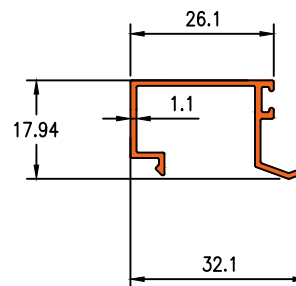

40MM OPENABLE WINDOW



Die No.16048

0.665KG/M

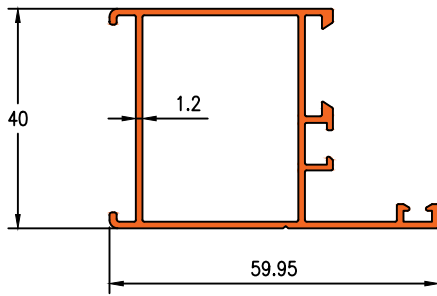

Die No.16047

0.806KG/M

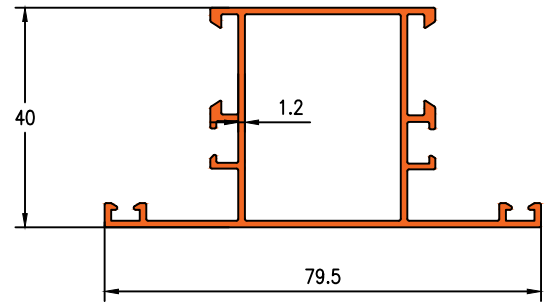

Die No.16055

0.701KG/M

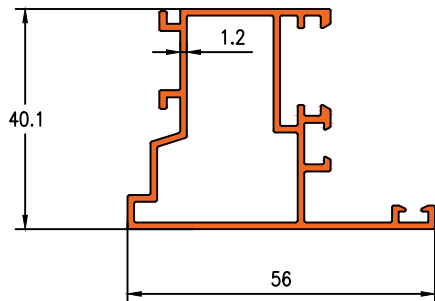

Die No.16126

0.660KG/M

